

PREPARED BY : DATE	SHARP	SPEC No. LD-20209A
APPROVED BY : DATE		FILE No.
		ISSUE : Feb. 7. 2008
	MOBILE LIQUID CRYSTAL DISPLAY GROUP SHARP CORPORATION	PAGE : 18 pages
	SPECIFICATION	APPLICABLE GROUP MOBILE LIQUID CRYSTAL DISPLAY GROUP

DEVICE SPECIFICATION FOR

TFT-LCD Module

MODEL No.

LQ104V1DG62

These parts have corresponded with the RoHS directive.

CUSTOMER'S APPROVAL

BY _____

BY *K. Shiono*

K. Shiono
 General manager
 ENGINEERING DEPARTMENT
 MOBILE LIQUID CRYSTAL DISPLAY DIVISION III
 MOBILE LIQUID CRYSTAL DISPLAY GROUP
 SHARP CORPORATION

1. Application

This specification applies to color 10.4VGA TFT-LCD module, LQ104V1DG62.

These specification sheets are the proprietary product of SHARP CORPORATION ("SHARP") and include materials protected under copyright of SHARP. Do not reproduce or cause any third party to reproduce them in any form or by any means, electronic or mechanical, for any purpose, in whole or in part, without the express written permission of SHARP.

The device listed in these **technical literature** sheets was designed and manufactured for use in general electronic equipment.

In case of using the device for applications such as control and safety equipment for transportation (controls of aircraft, trains, automobiles, etc.), rescue and security equipment and various safety related equipment which require higher reliability and safety, take into consideration that appropriate measures such as fail-safe functions and redundant system design should be taken.

Do not use the device for equipment that requires an extreme level of reliability, such as aerospace applications, telecommunication equipment (trunk lines), nuclear power control equipment and medical or other equipment for life support.

SHARP assumes no responsibility for any damage resulting from the use of the device which does not comply with the instructions and the precautions specified in these specification sheets.

Confirm "12. Handling Precautions" item when you use the device.

Contact and consult with a SHARP sales representative for any questions about this device.

2. Overview

This module is a color active matrix LCD module incorporating amorphous silicon TFT (Thin Film Transistor). It is composed of a color TFT-LCD panel, driver ICs, control circuit and power supply circuit and a White-LED backlight unit. Graphics and texts can be displayed on a 640×3×480 dots panel with 262,144 colors by supplying 18 bit data signal (6bit/color), four timing signals, +3.3V/5.0V DC supply voltage for TFT-LCD panel driving and supply voltage for backlight.

The TFT-LCD panel used for this module is a low-reflection and higher-color-saturation type.

Therefore, this module is also suitable for the multimedia use. Viewing angle is 6 o'clock direction.

This module is the type of wide viewing angle, superhigh brightness (550cd/m²) and high contrast (600:1).

The LED Backlight driving DC/DC converter and the cable are not built in this LCD module.

3. Outline specification.

Parameter	Specifications	Unit
Display size	26 (10.4") Diagonal	cm
Active area	211.2(H)×158.4(V)	mm
Pixel format	640(H)×480(V)	pixel
	(1 pixel=R+G+B dots)	-
Number of colors (Number of gray scale level)	262, 144 colors (64 gray scales per color)	
Pixel pitch	0.330(H)×0.330(V)	mm
Pixel configuration	R,G,B vertical stripe	-
Display mode	Normally white	-
Unit outline dimensions *1	246.5(W)×179.4(H)×Max.12.5(D)	mm
Mass	580(max)	g
Surface treatment	Anti-glare and hard-coating 3H	-

*1: Note: excluding back light cables (The backlight cable is not attached to the LCD unit.)

The thickness of module (D) doesn't contain the projection.

Outline dimensions is shown in Fig.1

4. Input Terminals

4-1. TFT-LCD panel driving

CN1 Used connector: DF9MA-31P-1V(32) (Hirose Electric Co., Ltd.)

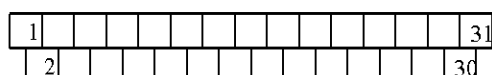

CN1 pin arrangement from module surface
(Transparent view)

Corresponding connector:

DF9-31S-1V(32), DF9A-31S-1V(32),
DF9B-31S-1V(32), DF9C-31S-1V(32)
(Hirose Electric Co., Ltd.)

(※) Please do not use it besides corresponding connector

Pin No.	Symbol	Function	Remark
1	GND	-	
2	CK	Clock signal for sampling each data signal	
3	Hsync	Horizontal synchronous signal	[Note1]
4	Vsync	Vertical synchronous signal	[Note1]
5	GND	-	
6	R0	RED data signal(LSB)	
7	R1	RED data signal	
8	R2	RED data signal	
9	R3	RED data signal	
10	R4	RED data signal	
11	R5	RED data signal(MSB)	
12	GND	-	
13	G0	GREEN data signal(LSB)	
14	G1	GREEN data signal	
15	G2	GREEN data signal	
16	G3	GREEN data signal	
17	G4	GREEN data signal	
18	G5	GREEN data signal(MSB)	
19	GND	-	
20	B0	BLUE data signal(LSB)	
21	B1	BLUE data signal	
22	B2	BLUE data signal	
23	B3	BLUE data signal	
24	B4	BLUE data signal	
25	B5	BLUE data signal(MSB)	
26	GND	-	
27	ENAB	Signal to settle the horizontal display position	[Note2]
28	Vcc	+3.3V / +5.0V power supply	
29	Vcc	+3.3V / +5.0V power supply	
30	R/L	Horizontal display mode select signal	[Note3]
31	U/D	Vertical display mode select signal	[Note4]

※The shielding case is connected with GND.

[Note1] The polarity of both synchronous signals are negative.

[Note2] The horizontal display start timing is settled in accordance with a rising timing of ENAB signal. In case ENAB is fixed "Low", the horizontal start timing is determined as described in 8-2. Don't keep ENAB "High" during operation.

[Note 3],[Note 4]

R/L = High, U/D = Low

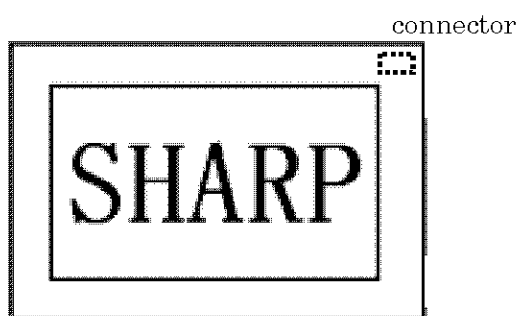

R/L = Low, U/D = Low

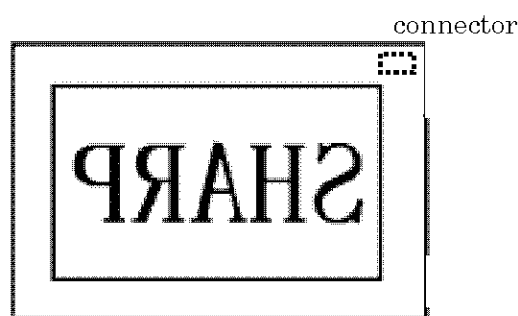

R/L = High, U/D = High

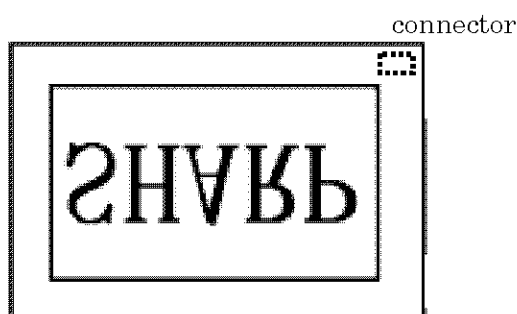

R/L = Low, U/D = High

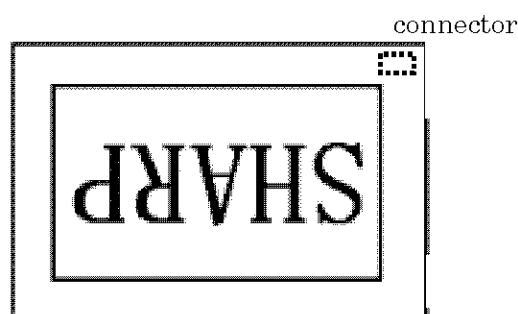

4-2. Backlight driving

CN2 Used connector : SM06B-SRSS-TB(LF)(SN) (JST)

Corresponding connector : SHR-06V-S-B (JST)

Pin no.	symbol	function
1	+ch3	Power supply for LED (Ch3 High voltage side)
2	+ch2	Power supply for LED (Ch2 High voltage side)
3	+ch1	Power supply for LED (Ch1 High voltage side)
4	- ch1	Power supply for LED (Ch1 Low voltage side)
5	- ch2	Power supply for LED (Ch2 Low voltage side)
6	- ch3	Power supply for LED (Ch3 Low voltage side)

5. Absolute Maximum Ratings

Parameter	Symbol	Condition	Ratings	Unit	Remark
Input voltage	V_I	$T_a=25^\circ\text{C}$	-0.3 to $V_{cc}+0.3$	V	[Note1]
Lamp input current	I_L	-	350	mA	
supply voltage	V_{cc}	$T_a=25^\circ\text{C}$	0 to +6.0	V	
Storage temperature	T_{stg}	-	-30 to +80	$^\circ\text{C}$	[Note2]
Operating temperature	T_{opa}	Panel surface	-30 to +80	$^\circ\text{C}$	

[Note1] CK,R0~R5,G0~G5,B0~B5,Hsync,Vsync,ENAB,R/L,U/D

[Note2] Humidity: 95%RH Max. at $T_a \leq 40^\circ\text{C}$.Maximum wet-bulb temperature at 39°C or less at $T_a > 40^\circ\text{C}$.

No condensation.

6. Recommended operation condition

Parameter	Symbol	Min.	Typ.	Max.	Unit	Remark
Input voltage	V_I	0		V_{CC}	V	[Note1]
Supply voltage	V_{CC}	+3.0	+3.3/+5.0	+5.5	V	[Note2]
Ambient temperature	T_{opa}	-30		+80	°C	[Note3], [Note4]

[Note1] CK,R0~R5,G0~G5,B0~B5,Hsync,Vsync,ENAB,R/L,U/D

[Note2]

Vcc-turn-on conditions

- $0 < t_1 \leq 15\text{ms}$
- $0 < t_2 \leq 10\text{ms}$
- $0 < t_3 \leq 100\text{ms}$
- $0 < t_4 \leq 1\text{s}$
- $t_5 > 200\text{ms}$

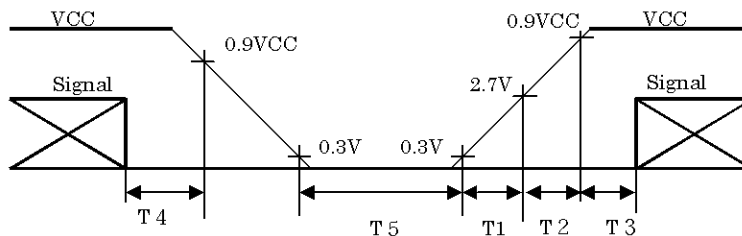

Vcc-dip conditions

- 1) $2.5\text{V} \leq V_{CC}$
 $t_d \leq 10\text{ms}$
- 2) $V_{CC} < 2.5\text{V}$

Vcc-dip conditions should also follow the Vcc-turn-on conditions

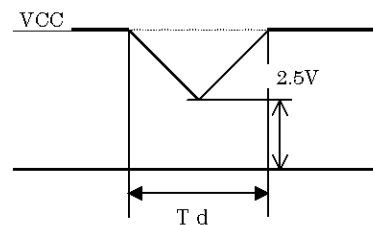

[Note3] Humidity: 95%RH Max. at $T_a \leq 40^\circ\text{C}$.

Maximum wet-bulb temperature at 39°C or less at $T_a > 40^\circ\text{C}$.

No condensation.

[Note4] Maximum value : Panel surface temperature

7. Electrical Characteristics

7-1. TFT-LCD panel driving

Ta=25°C

Parameter		Symbol	Min.	Typ.	Max.	Unit	Remark
Current dissipation	Vcc=3.3V	Icc	-	200	300	mA	[Note1]
	Vcc=5.0V	Icc	-	130	200	mA	
Permissive input ripple voltage		VRP	-	-	100	mVp-p	
Input voltage	Low	VIL	-	-	0.8	V	[Note2]
Input voltage	High	VIH	2.1	-	-	V	
Input current 1	Low(VI=0V)	IOL1	-10.0	-	10.0	μA	[Note3],[Note6]
	Hogh(VI=Vcc)	IOH1	-10.0	-	10.0	μA	
Input current 2	Low(VI=0V)	IOL2	-800	-	-	μA	[Note4],[Note6]
	Hogh(VI=Vcc)	IOH2	-10.0	-	10.0	μA	
Input current 3	Low(VI=0V)	IOL3	-10.0	-	10.0	μA	[Note5],[Note6]
	Hogh(VI=Vcc)	IOH3	-	-	800	μA	

[Note1] Typical current situation : 16-gray-bar pattern.

Vcc=+3.3V/+5.0V

[Note2] CK,R0~R5,G0~G5,B0~B5,Hsync,Vsync,ENAB, R/L,U/D

[Note3] CK,R0~R5,G0~G5,B0~B5,Hsync,Vsync,ENAB,

[Note4] R/L

[Note5] U/D

[Note6] See below block diagram of input interface.

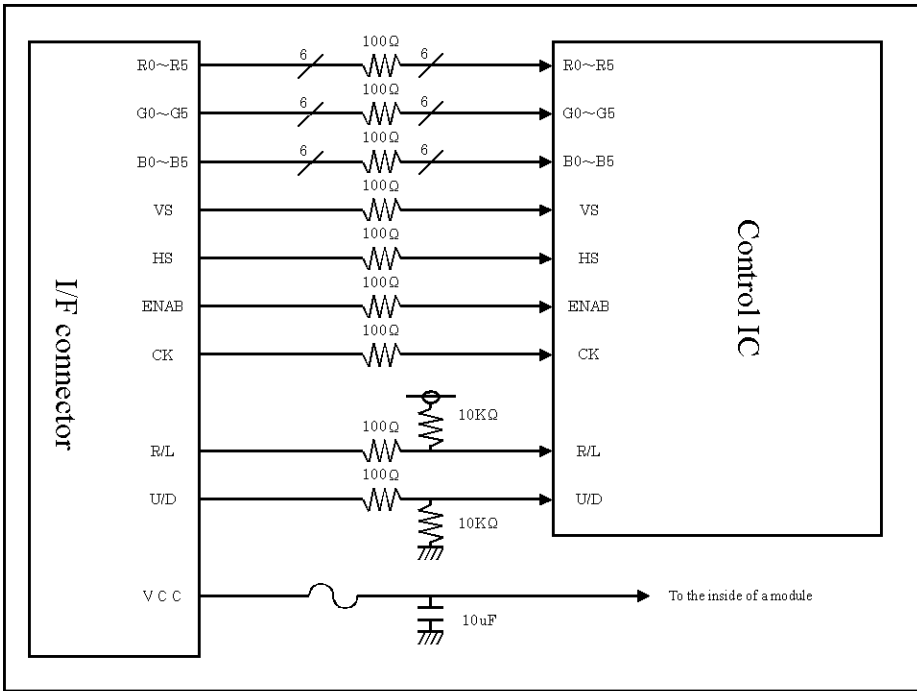
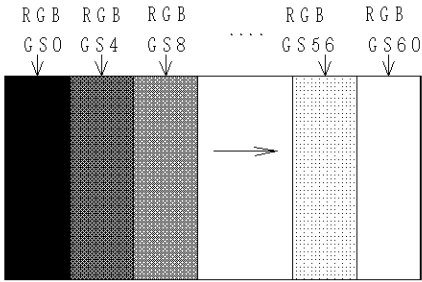

7-2. Backlight driving

The backlight system is an edge-lighting type with white-LED.

The characteristics of LED are shown in the following table.

(It is usually required to measure under the following condition.

condition: Constant current drive, $T_a = 25^\circ\text{C} \pm 2^\circ\text{C}$)

Parameter	Symbol	Min.	Typ.	Max.	Unit	Remark
LED voltage	V_L	—	18.6	21.6	V	
LED current range	I_L	—	80	100	mArms	Value for one channel [Note 1]
Number of circuit channel		—	3	—		[Note 2]
Lamp power consumption	W_L	—	4.5	6.5	W	[Note 3]
Life time (LCD module)	L_L	50,000	—	—	Hour	[Note 4]

*LED : NICHIA CORPORATION (NFSW-TYPE)

[Note 1] The LED current is recommended to be used by 80mA or less to suppress the LED deterioration.

[Note 2] The LED backlight is composed of 3 channels which 6 LED is connected in series.

[Note 3] Calculated value for reference ($I_L \times V_L \times 3$ channel)

[Note 4]①Lighting condition:

- The state of the LCD module installation: Landscape position and standing position
- Atmosphere temperature: 25°C
- Lighting current: 80mA (Constant current drive / Continuous turning on)

②Definition of Life time:

Brightness becomes 50% of the original value .(under condition ①)

8. Timing Characteristics of input signals

Timing diagrams of input signal are shown in Fig.2.

8-1. Timing characteristics

Parameter		Symbol	Min.	Typ.	Max.	Unit	Remark
Clock	Frequency	$1/T_c$	23	25.18	28.33	MHz	-
	High time	T_{ch}	5	-	-	ns	-
	Low time	T_{cl}	10	-	-	ns	-
	Duty ratio	T_h/T	40	50	60	%	-
Data	Setup time	T_{ds}	5	-	-	ns	-
	Hold time	T_{dh}	10	-	-	ns	-
Horizontal sync. signal	Cycle	T_H	30.00	31.78	-	μs	-
			750	800	900	clock	-
Vertical sync. signal	Cycle	T_V	515	525	560	line	-
	Pulse width	T_{Vp}	1	-	34	line	-
Horizontal display period		T_{Hd}	640	640	640	clock	-
Hsync-Clock phase difference		T_{Hc}	10	-	$T_c - 10$	ns	-
Hsync-Vsync phase difference		T_{Vh}	0	-	$T_H - T_{Hp}$	clock	-
Vertical data start position		T_{Vs}	34	34	34	line	-

[Note] In case of lower frequency, the deterioration of display quality, flicker etc., may be occurred.

8-2. Horizontal display position

The horizontal display position is determined by ENAB signal and the input data corresponding to the rising edge of ENAB signal is displayed at the left end of the active area.

Parameter		symbol	Min.	Typ.	Max.	Unit	Remark
Enable signal	Setup time	Tes	5	-	Tc-10	ns	-
	Pulse width	Tep	2	640	TH-10	clock	-
Hsync-Enable signal phase difference		THe	44	-	TH—664	clock	-

[Note] When ENAB is fixed "Low", the display starts from the data of C104(clock) as shown in Fig.2.

Be careful that the module does not work when ENAB is fixed "High".

When the phase difference is below 104 clock, keep the "High level of ENAB is signal longer than 104-THe. If it will not be kept, the display starts from the data of C104(clock).

8-3. Vertical display position

The vertical display position, TVs is fixed "34" (line).

8-4. Input Data Signals and Display Position on the screen

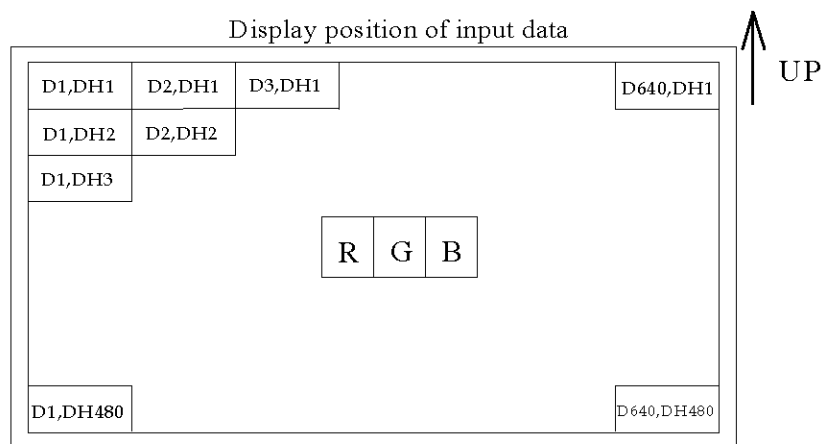

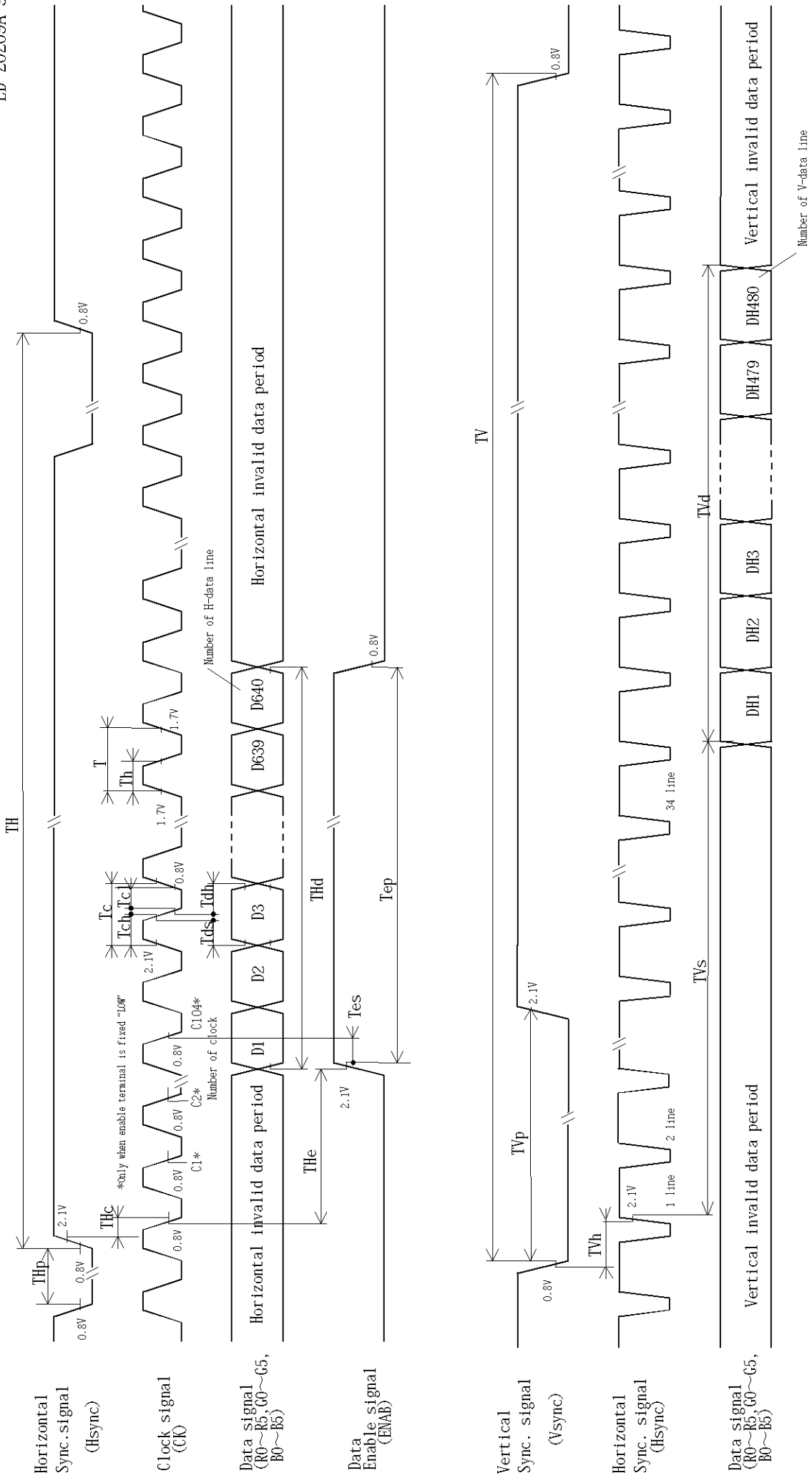

Fig. 2 Input signal waveforms

9. Input Signals, Basic Display Colors and Gray Scale of Each Color

	Colors &	Data signal																		
	Gray scale	Gray Scale	R0	R1	R2	R3	R4	R5	G0	G1	G2	G3	G4	G5	B0	B1	B2	B3	B4	B5
Basic Color	Black	—	0	0	0	0	0	0	0	0	0	0	0	0	0	0	0	0	0	0
	Blue	—	0	0	0	0	0	0	0	0	0	0	0	0	1	1	1	1	1	1
	Green	—	0	0	0	0	0	0	1	1	1	1	1	1	0	0	0	0	0	0
	Cyan	—	0	0	0	0	0	0	1	1	1	1	1	1	1	1	1	1	1	1
	Red	—	1	1	1	1	1	1	0	0	0	0	0	0	0	0	0	0	0	0
	Magenta	—	1	1	1	1	1	1	0	0	0	0	0	0	1	1	1	1	1	1
	Yellow	—	1	1	1	1	1	1	1	1	1	1	1	1	0	0	0	0	0	0
	White	—	1	1	1	1	1	1	1	1	1	1	1	1	1	1	1	1	1	1
Gray Scale of Red	Black	GS0	0	0	0	0	0	0	0	0	0	0	0	0	0	0	0	0	0	0
	↑	GS1	1	0	0	0	0	0	0	0	0	0	0	0	0	0	0	0	0	0
	Darker	GS2	0	1	0	0	0	0	0	0	0	0	0	0	0	0	0	0	0	0
	↑	↓	↓					↓					↓							
	↓	↓	↓					↓					↓							
	Brighter	GS61	1	0	1	1	1	1	0	0	0	0	0	0	0	0	0	0	0	0
	↓	GS62	0	1	1	1	1	1	0	0	0	0	0	0	0	0	0	0	0	0
	Red	GS63	1	1	1	1	1	1	0	0	0	0	0	0	0	0	0	0	0	0
Gray Scale of Green	Black	GS0	0	0	0	0	0	0	0	0	0	0	0	0	0	0	0	0	0	0
	↑	GS1	0	0	0	0	0	0	1	0	0	0	0	0	0	0	0	0	0	0
	Darker	GS2	0	0	0	0	0	0	0	1	0	0	0	0	0	0	0	0	0	0
	↑	↓	↓					↓					↓							
	↓	↓	↓					↓					↓							
	Brighter	GS61	0	0	0	0	0	0	1	0	1	1	1	1	0	0	0	0	0	0
	↓	GS62	0	0	0	0	0	0	0	1	1	1	1	1	0	0	0	0	0	0
	Green	GS63	0	0	0	0	0	0	1	1	1	1	1	1	0	0	0	0	0	0
Gray Scale of Blue	Black	GS0	0	0	0	0	0	0	0	0	0	0	0	0	0	0	0	0	0	0
	↑	GS1	0	0	0	0	0	0	0	0	0	0	0	0	1	0	0	0	0	0
	Darker	GS2	0	0	0	0	0	0	0	0	0	0	0	0	0	1	0	0	0	0
	↑	↓	↓					↓					↓							
	↓	↓	↓					↓					↓							
	Brighter	GS61	0	0	0	0	0	0	0	0	0	0	0	0	1	0	1	1	1	1
	↓	GS62	0	0	0	0	0	0	0	0	0	0	0	0	0	1	1	1	1	1
	Blue	GS63	0	0	0	0	0	0	0	0	0	0	0	0	1	1	1	1	1	1

0 :Low level voltage, 1 : High level voltage

Each basic color can be displayed in 64 gray scales from 6 bit data signals. According to the combination of total 18 bit data signals, the 262,144-color display can be achieved on the screen.

10. Optical Characteristics

Ta=25°C, Vcc=+3.3V / +5.0V

Parameter		Symbol	Condition	Min.	Typ.	Max.	Unit	Remark
Viewing angle range	Horizontal	θ_{21}, θ_{22}	CR>10	60	70	-	Deg.	[Note1]
	Vertical	θ_{11}		35	50	-	Deg.	[Note4]
		θ_{12}		55	60	-	Deg.	
Contrast ratio		CRn	$\theta=0^\circ$	300	-	-		[Note2]
		CRo	Optimum viewing angle	-	600	-		[Note4]
Response time	Rise	τ_r	$\theta=0^\circ$	-	10	-	ms	[Note3]
	Decay	τ_d		-	25	-	ms	[Note4]
Chromaticity of white		x		0.255	0.313	0.375		[Note4] If=80mA Ta=25°C
		y		0.288	0.343	0.410		
Chromaticity of red		x		0.520	0.569	0.620		
		y		0.279	0.327	0.375		
Chromaticity of green		x		0.287	0.339	0.390		
		y		0.507	0.562	0.619		
Chromaticity of blue		x		0.127	0.175	0.225		
		y		0.131	0.182	0.238		
Luminance of white		Y_{L1}	400	550	-	cd/m ²		
White Uniformity		δW	-	-	1.35		[Note5]	

[Note] The measurement shall be executed 30 minutes after lighting at rating. (condition:If=80mA)

The optical characteristics shall be measured in a dark room or equivalent state with the method shown in Fig.3 below.

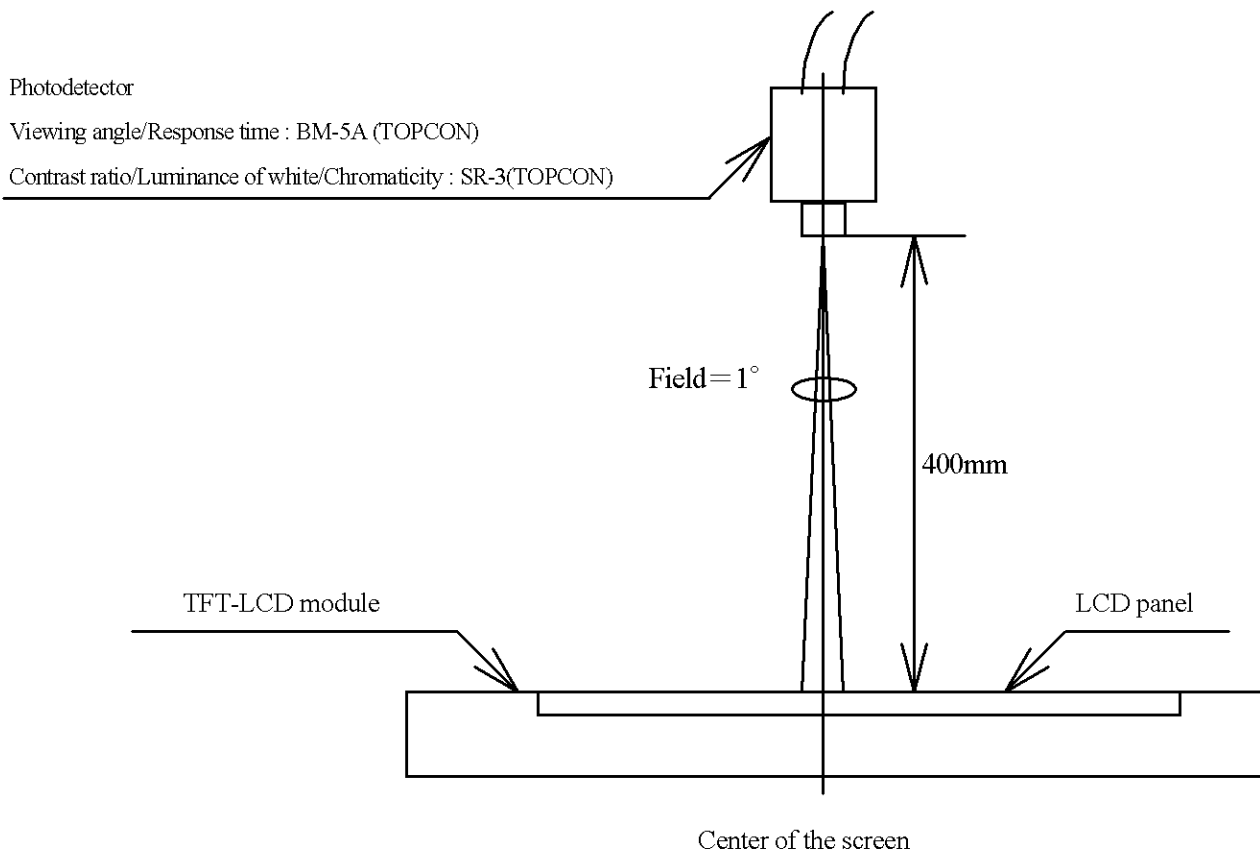
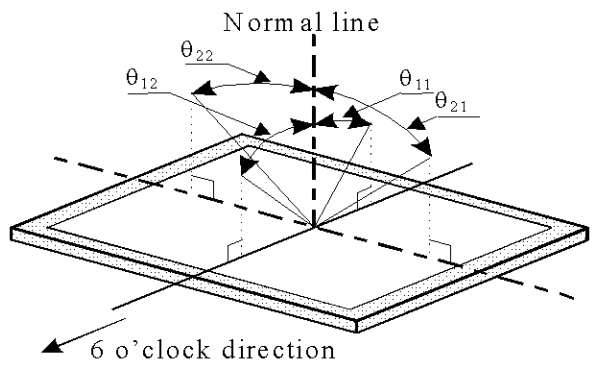

Fig.3 Optical characteristics measurement method

[Note1] Definitions of viewing angle range:



[Note2] Definition of contrast ratio:

The contrast ratio is defined as the following.

$$\text{Contrast Ratio (CR)} = \frac{\text{Luminance (brightness) with all pixels white}}{\text{Luminance (brightness) with all pixels black}}$$

[Note3] Definition of response time:

The response time is defined as the following figure and shall be measured by switching the input signal for "black" and "white" .

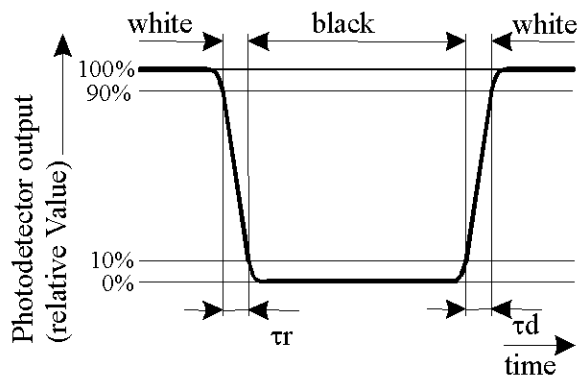

[Note4] This shall be measured at center of the screen.

[Note5] Definition of white uniformity:

White uniformity is defined as the following with five measurements (A~E).

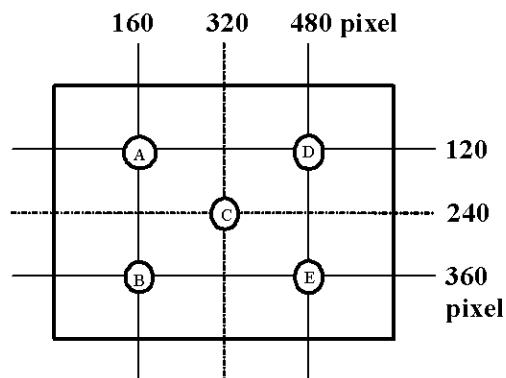

$$\delta_w = \frac{\text{Maximum Luminance of five points (brightness)}}{\text{Minimum Luminance of five points (brightness)}}$$

11. Display Quality

The display quality of the color TFT-LCD module shall be in compliance with the Incoming Inspection Standard.

12. Handling Precautions

- a) Be sure to turn off the power supply when inserting or disconnecting the cable.
- b) Be sure to design the cabinet so that the module can be installed without any extra stress such as warp or twist.
- c) Since the front polarizer is easily damaged, pay attention not to scratch it.
Blow away dust on the polarizer with antistatic N_2 blow. It is undesirable to wipe off because a polarizer is sensitive. It is recommended to peel off softly using the adhesive tape when soil or finger oil is stuck to the polarizer.
When unavoidable, wipe off carefully with a cloth for wiping lenses.
- d) Wipe off water drop immediately. Long contact with water may cause discoloration or spots.
- e) When the panel surface is soiled, wipe it with absorbent cotton or other soft cloth.
- f) Since the panel is made of glass, it may break or crack if dropped or bumped on hard surface.
Handle with care.
- g) Since CMOS LSI is used in this module, take care of static electricity and injure the human earth when handling. Observe all other precautionary requirements in handling components.
- h) Since there is a circuit board in the module back, stress is not added at the time of a design assembly.
Please make it like. If stress is added, there is a possibility that circuit parts may be damaged.
- i) Protection film is attached to the module surface to prevent it from being scratched .
Peel the film off slowly , just before the use, with strict attention to electrostatic charges.
Blow off 'dust' on the polarizer by using an ionized nitrogen.
- j) The polarizer surface on the panel is treated with Anti-Glare for low reflection. In case of attaching protective board over the LCD, be careful about the optical interface fringe etc. which degrades display quality.
- k) Do not expose the LCD panel to direct sunlight. Lightproof shade etc. should be attached when LCD panel is used under such environment.
- l) Connect GND to 4 place of mounting holes to stabilize against EMI and external noise.
- m) When handling LCD modules and assembling them into cabinets, please be noted that long-term storage in the environment of oxidization or deoxidization gas and the use of such materials as reagent, solvent, adhesive, resin, etc. which generate these gasses, may cause corrosion and discoloration of the LCD modules. Do not use the LCD module under such environment.
- n) When install LCD modules in the cabinet, recommended torque value is " $0.294 \pm 0.02 N \cdot m$ ($3.0 \pm 0.2 \text{kgf} \cdot \text{cm}$)".
Be sure to confirm it in the same condition as it is installed in your instrument.
- o) Liquid crystal contained in the panel may leak if the LCD is broken. Rinse it as soon as possible if it gets inside your eye or mouth by mistake.
- p) Notice: Never dismantle the module , because it will cause failure.
Please do not peel off the white tape pasted to the product. However, the panel protection film is excluded.
- q) Be careful when using it for long time with fixed pattern display as it may cause afterimage.
- r) Adjusting volume have been set optimally before shipment, so do not change any adjusted value.
If adjusted value is changed, the specification may not be satisfied.
- s) If a minute particle enters in the module and adheres to an optical material, it may cause display non-uniformity issue, etc. Therefore, fine-pitch filters have to be installed to cooling and inhalation hole if you intend to install a fan.
- t) The LED used for this product is very sensitive to the temperature. Luminance decreases rapidly when it is used for a long time under the environment of the high temperature. Please consult our company when it is used under the environment like the above mentioned.

13. Packing form

Product countries / Areas	CHINA		
Piling number of cartons	6 (max)		
Package quantity in one carton	10pcs		
Carton size	468×253×323(H)		
Total mass of one carton filled with full modules	7.5Kg(typ)		
Packing form is shown	Fig.4		

14. Reliability test items

No.	Test item	Conditions	Remark
1	High temperature storage test	Tpa=80℃ 240h	Panel surface
2	Low temperature storage test	Ta= -30℃ 240h	
3	High temperature & high humidity operation test	Ta=40℃ ; 95%RH 240h (If=80mA) (No condensation)	
4	High temperature operation test	Tpa=80℃ 240h (If=80mA)	Panel surface
5	Low temperature operation test	Ta= -30℃ 240h (If=80mA)	
6	Vibration test (non- operating)	Frequency: 10~57Hz/Vibration width (one side): 0.115mm : 57~500Hz/Gravity: 19.6 m/s ² Sweep time : 11 minutes Test period : 3 hours (1 hour for each direction of X,Y,Z)	
7	Shock test (non- operating)	Max. gravity : 490m/s ² Pulse width : 11ms, half sine wave Direction : ±X, ±Y, ±Z once for each direction.	
8	ESD test	Contact discharge (150pF,330Ω) Non-operating = ±10kV ,operating= ±8 k V Atmospheric discharge (150pF,330Ω) Non-operating = ±20kV ,operating= ±15 k V	
9	EMI	Measurement in 10m site Display position on the screen="H"(full-screen) GND to 4 place=un-connect Vcc/Vsignal=typ	VCCI (Class B)

[Result Evaluation Criteria]

Under the display quality test conditions with normal operation state, these shall be no change which may affect practical display function. (normal operation state : Temperature:15~35℃, Humidity:45~75%, Atmospheric pressure:86~106kpa)

15.Others

15-1 Lot No. Label:

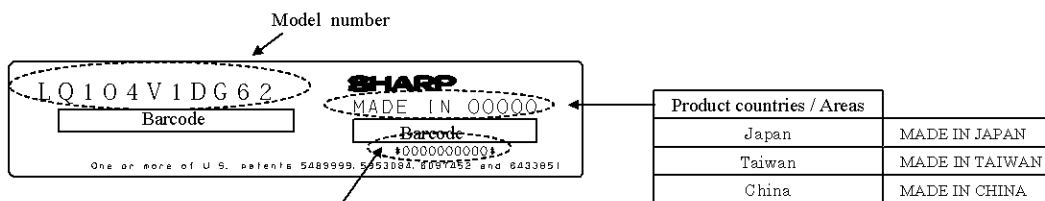

Lot Number:

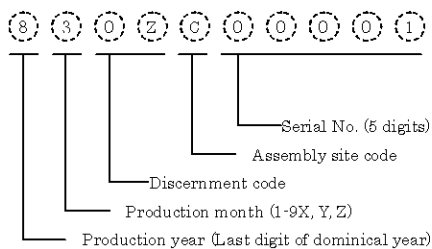

15-2 Packing box Label:

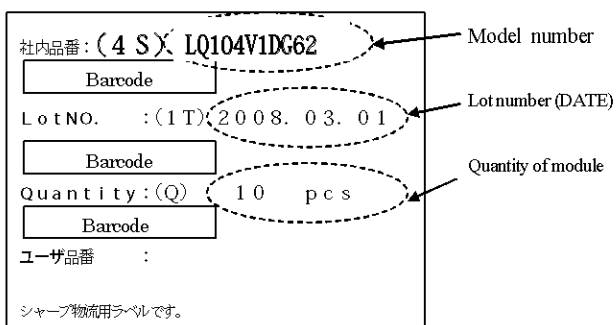

※R.C. (RoHs Compliance) means these parts have corresponded with the RoHs directive.

15-3 If any problem occurs in relation to the description of **this specification**, it shall be resolved through discussion with spirit of cooperation.

16. Storage conditions

<Environmental condition range of storage temperature and humidity>

Temperature 0 to 40 degrees Celsius

Relative humidity 95% and below

【note】 Please refer below as a mean value of the environmental conditions.

Summer time temperature 20 to 35 degrees Celsius

humidity 85% and below

Winter time temperature 5 to 15 degrees Celsius

humidity 85% and below

Please maintain within 240 hours of accumulated length of storage time, with conditions of 40 degrees Celsius and room humidity of 95%.

Direct sun light Please keep the product in a dark room or cover the product to protect from direct sun light.

Atmospheric condition Please refrain from keeping the product with possible corrosive gas or volatile flux.

Prevention of dew * Please store the product carton either on a wooden pallet or a stand / rack to prevent dew. Do not place directly on the floor. In addition, to obtain moderate ventilation in between the pallet's top and bottom surfaces, pile the cartons up in a single direction and in order.

* Please place the product cartons away from the storage wall.

* Please maintain the storage area with an appropriate ventilation. It is recommendable to furnish the storage area with equipments such as ventilation systems.

* Please maintain the ambient temperature within the range of natural environmental fluctuation.

Storage period Within above mentioned conditions, maximum storage period should be one year.

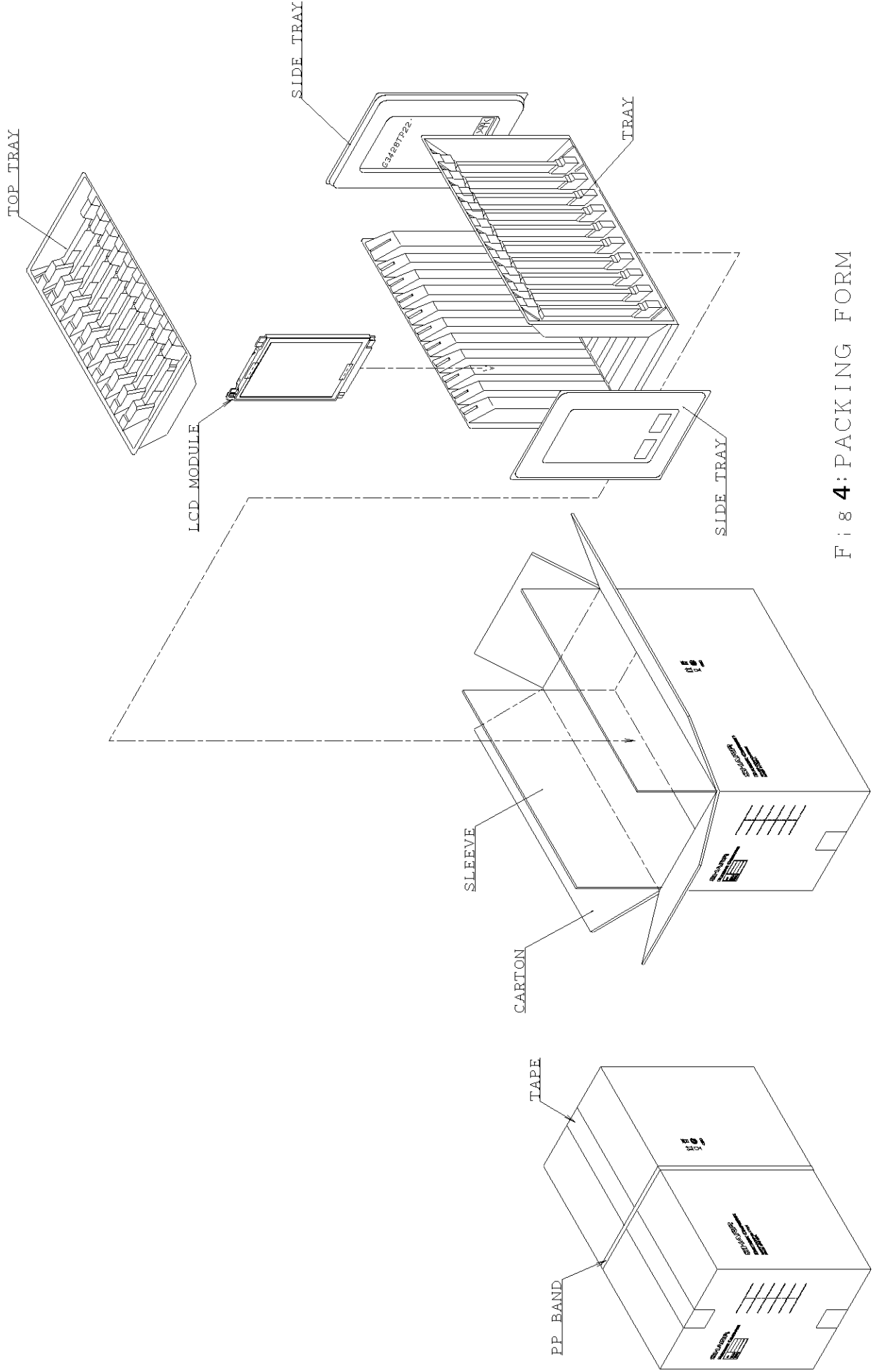

Fig 4: PACKING FORM