

# TOSHIBA

LIQUID CRYSTAL DISPLAY DIVISION  
PRODUCT INFORMATION

26cm COLOUR TFT-LCD MODULE  
(10.4 TYPE)  
**LTM10C306L**  
(p-Si TFT)

## FEATURES

- (1) 10.4"XGA display size for notebook PC
- (2) LVDS interface system
- (3) Slim(5.5mmMAX) & light weight(265gTYP) design

**TENTATIVE**

## MECHANICAL SPECIFICATIONS

Item	Specifications
Dimensional Outline (typ.)	241.5(W) x 171.9(H) x 5.5max(D) mm
Number of Pixels	1024(W) x 768(H) pixels
Active Area	210.432(W) x 157.824(H) mm
Pixel Pitch	0.2055(W) x 0.2055(H)
Weight (approximately)	265g
Backlight	Single CCFL, Sidelight type

## ABSOLUTE MAXIMUM RATINGS

Item	Min.	Max.	Unit	
Supply Voltage	(V <sub>DD</sub> )	-0.3	4.5	V
	(V <sub>FL</sub> )	0	2.0	kVrms
FL Driving Frequency (f <sub>FL</sub> )	-	100	kHz	
Input Signal Voltage (V <sub>IN</sub> )	-0.3	V <sub>DD</sub> +0.3	V	
Operating Temperature	0	50	°C	
Storage Temperature	-20	60	°C	
Storage Humidity	10	90	%RH	

## ELECTRICAL SPECIFICATION

Item	Min.	Typ.	Max.	Unit	Remarks	
Supply Voltage	(V <sub>DD</sub> )	3.0	3.3	3.6	V	
	(V <sub>FL</sub> )	---	(650)	---	Vrms	I <sub>FL</sub> =2.5 mArms
FL Start Voltage (Ta=0°C)	(1200)	---	1600	Vrms		
Receiver Input Voltage	0	---	2.4	V		
Differential Input High Threshold(V <sub>TH</sub> )*1	---	---	V <sub>CM</sub> +0.1	V	V <sub>CM</sub> =+1.2V	
Differential Input Low Threshold(V <sub>TL</sub> )*1	V <sub>CM</sub> -0.1	---	---	V	V <sub>CM</sub> =+1.2V	
Current Consumption	*2 (I <sub>DD</sub> )	---	360	mA		
	*3 (I <sub>FL</sub> )	2.0	2.5	5.0	mArms	
*2 *3 Power Consumption	---	(2.8)	---	W	@70cd/m <sup>2</sup>	

\*1 : Refer to DF90CF364 Specification by National Semiconductor Corporation. This LCD module conforms to LVDS standard (TIA/EIA-644)

\*2 : 8 color bars pattern

\*3 : Excepting the efficiency FL inverter

## OPTICAL SPECIFICATION (Ta=25°C)

Item	Min.	Typ.	Max.	Unit	Remarks
Contrast Ratio (CR)	100	250	---	---	
Response Time	(t <sub>ON</sub> )	---	50	ms	
	(t <sub>OFF</sub> )	---	50	ms	
Luminance (L)	50	70	---	cd/m <sup>2</sup>	I <sub>FL</sub> =2.5mArms
	---	200	---	cd/m <sup>2</sup>	I <sub>FL</sub> =5mArms

\*The information contained herein is presented only as a guide for the applications of our products. No responsibility is assumed by Toshiba or other rights of the third parties which may result from its use. No license is granted by implication or otherwise under any patent or patent rights of Toshiba or others.

\*The information contained herein may be changed without prior notice. It is therefore advisable to contact Toshiba before proceeding with the design of equipment incorporating this product.

**DIMENSIONAL OUTLINE (front figure)**

Unit : mm

Standard tolerance : 0.5

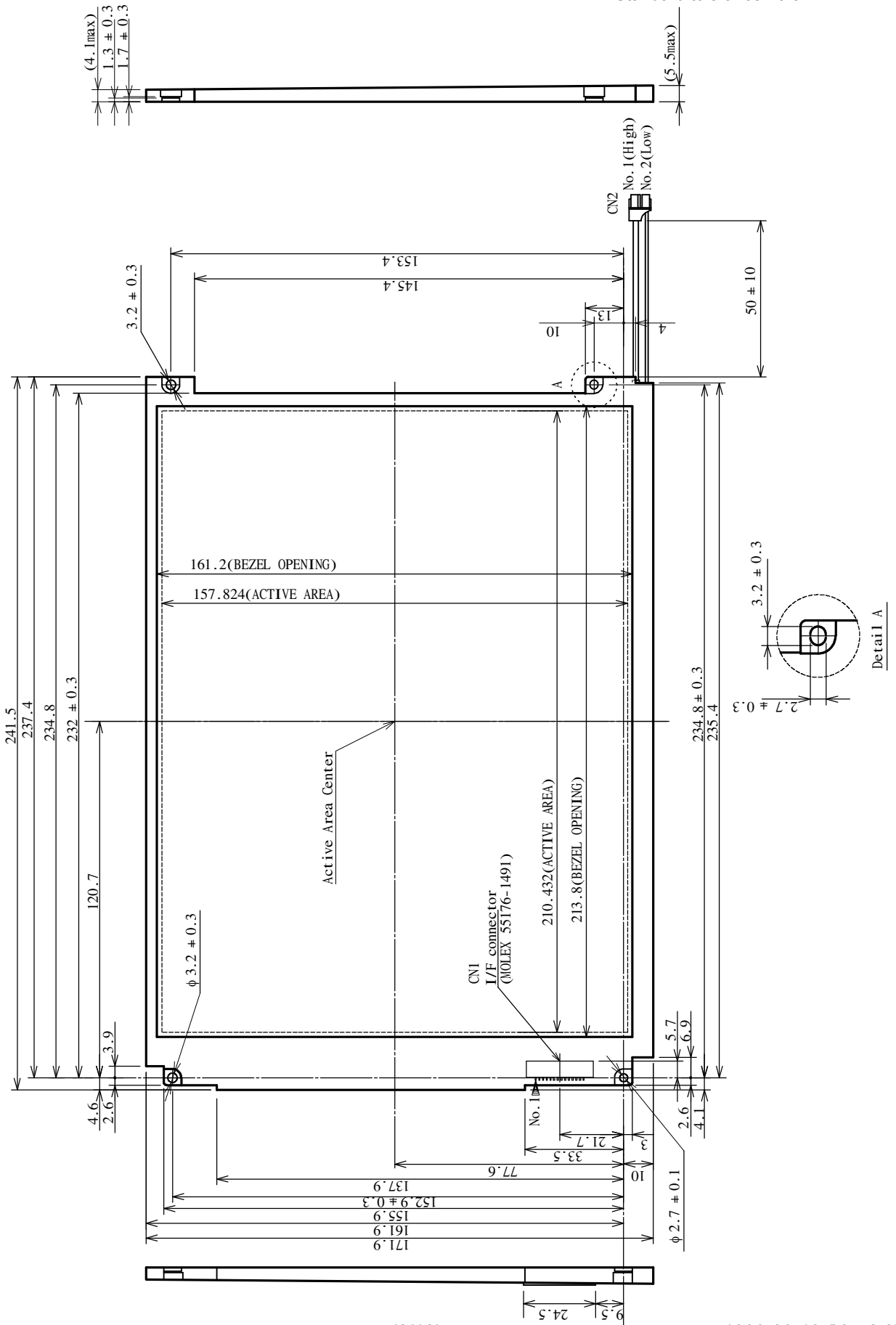

**BLOCK DIAGRAM**

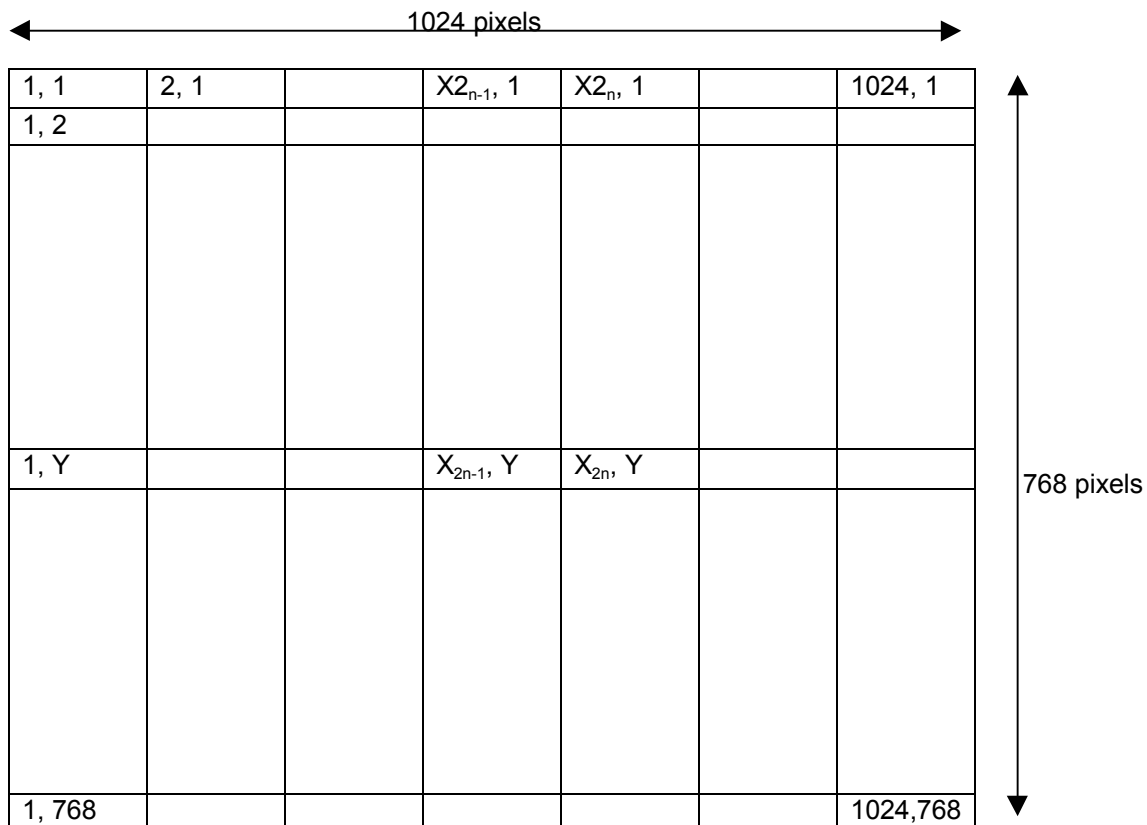
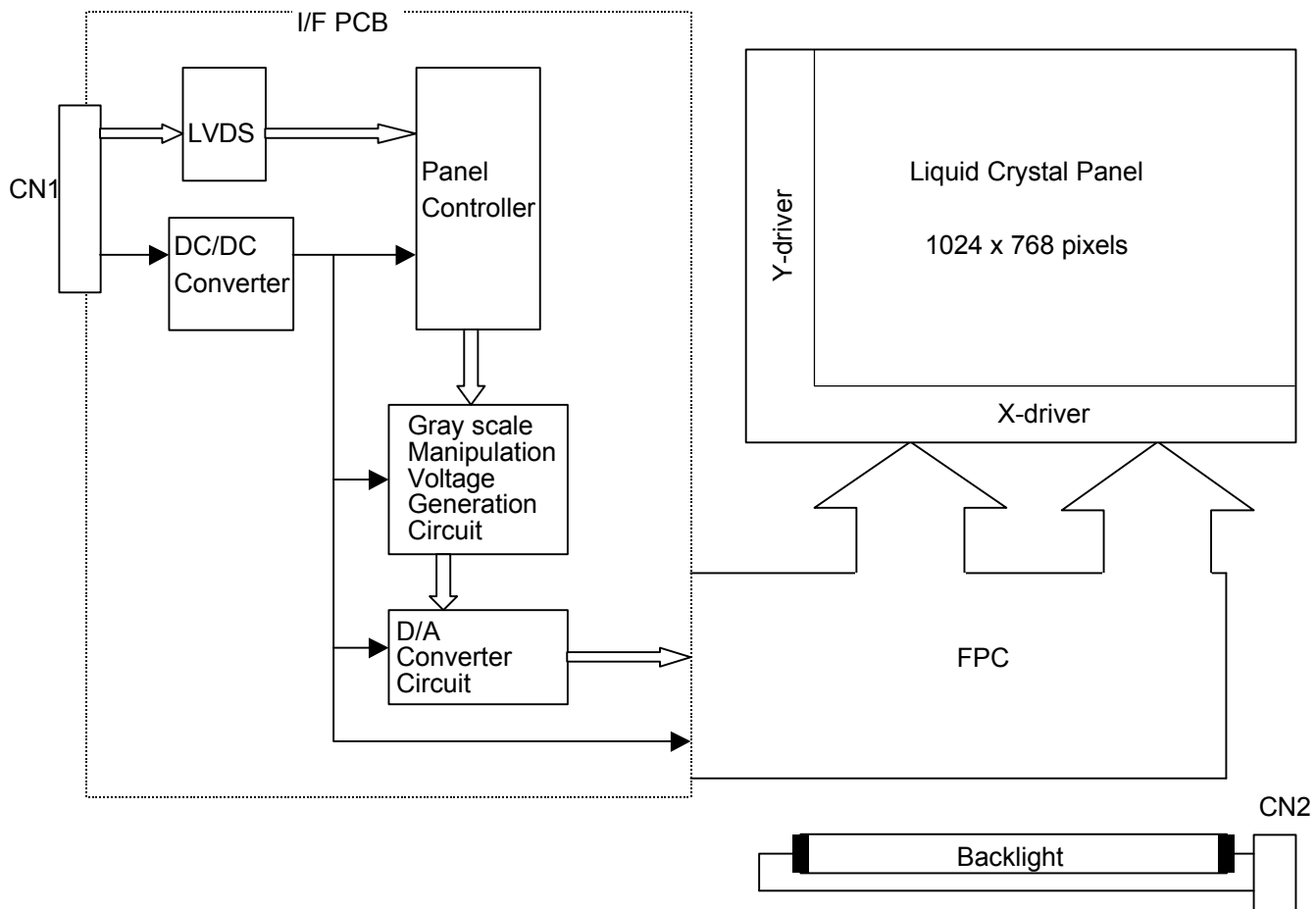

TIMING CHART

(1) Vertical Timing

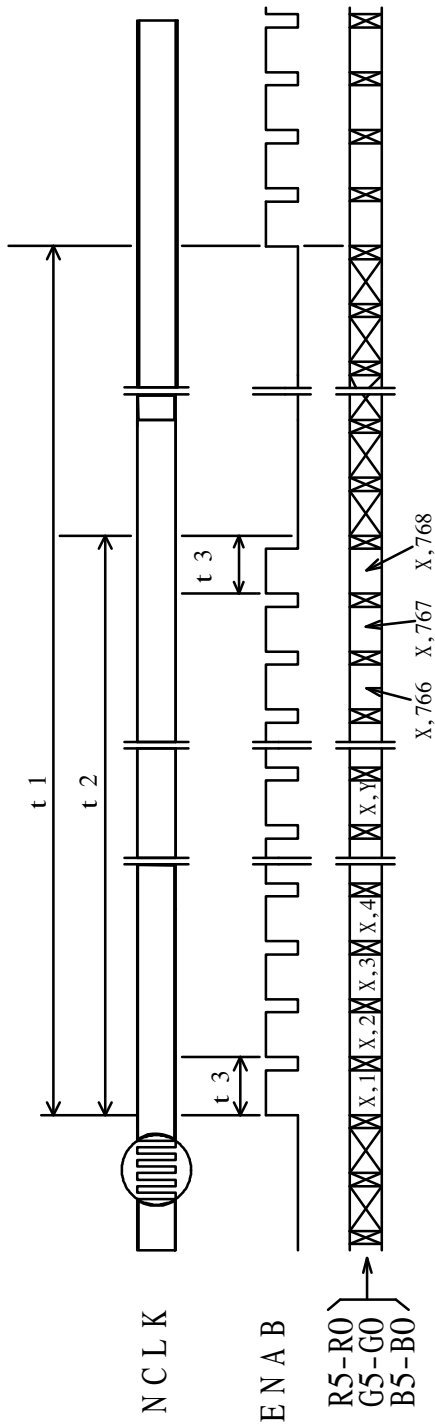

(2) Horizontal Timing

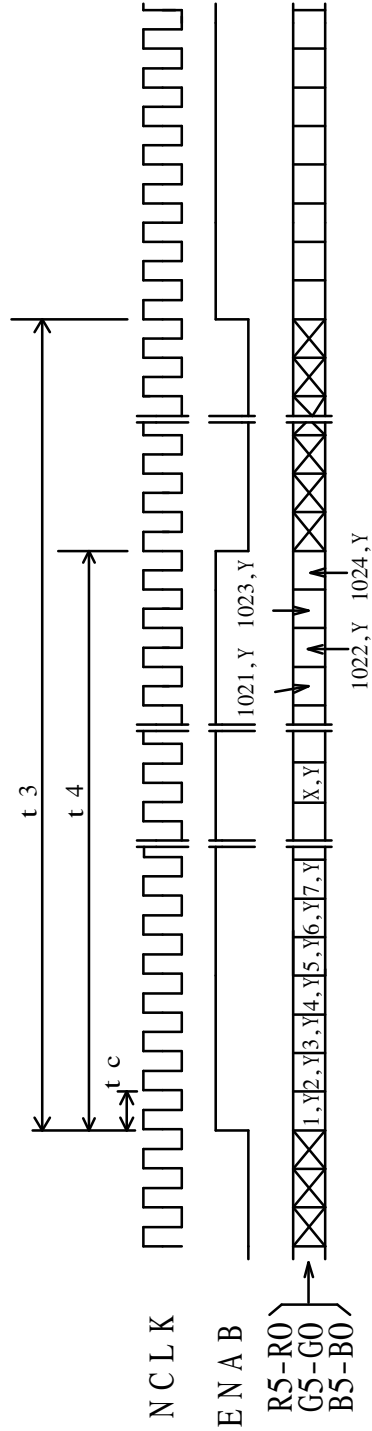

**TIMING SPECIFICATION** <sup>2) 3) 4)</sup>

Item	Symbol	Min.	Typ.	Max.	Unit	Remarks
Frame Period	t1	(778) x t3	806 x t3 16.67	(860) x t3 (17.25)	--- ms	1) 5)
Vertical Display Term	t2	768 x t3	768 x t3	768 x t3	---	1)
One Line Scanning Time	t3	1319 x tc 20.0	1344 x tc 20.68	1362 x tc ---	--- μs	1) 5)
Horizontal Display Term	t4	1024 x tc	1024 x tc	1024 x tc	---	1)
Clock Period	tc	15.0	15.38	---	ns	

Note 1) Refer to TIMING CHART at page4 and LVDS specification (DS90CF364) by National Semiconductor Corporation.

Note 2) When ENAB is fixed to "H" level or "L" level after NCLK input, the panel is displayed as black. However, it may be occurred a flicker on the display.

Note 3) When NCLK is fixed to "H" level or "L" level, the panel becomes white stage after several seconds.

Note 4) Do not change t1 and t3 values in the operation. When t1 or t3 is changed, the panel is displayed as black.

Note 5) Please adjust LCD operating signal timing and FL driving frequency, to optimize the display quality. There is a possibility that flicker is observed by the interference of LCD operating signal timing and FL driving condition (especially driving frequency).

## CONNECTOR PIN ASSIGNMENT FOR INTERFACE

### CN1 INPUT SIGNAL

Connector :55176-1491 / MOLEX JAPAN CO., LTD.

Mating Connector : 51146-1400(housing) / MOLEX JAPAN CO., LTD.

Terminal No.	Symbol	Function
1	VDD	Power Supply : +3.3V
2	VDD	Power Supply : +3.3V
3	GND	
4	GND	
5	CK+	Sampling Clock (Positive : + )
6	CK-	Sampling Clock (Negative : - )
7	IN2+	Transmission Data of Pixels 2 (Positive : + )
8	IN2-	Transmission Data of Pixels 2 (Negative : - )
9	IN1+	Transmission Data of Pixels 1 (Positive : + )
10	IN1-	Transmission Data of Pixels 1 (Negative : - )
11	IN0+	Transmission Data of Pixels 0 (Positive : + )
12	IN0-	Transmission Data of Pixels 0 (Negative : - )
13	GND	
14	GND	

### CN2 CCFL POWER SOURCE

Connector : HV-2S-C1C3 / JAPAN AVIATION ELECTRONICS INDUSTRY, LTD.

Mating Connector : HV-2P-HF / JAPAN AVIATION ELECTRONICS INDUSTRY, LTD.

Terminal No.	Symbol	Function
1	VL	CCFL Power Supply ( high voltage)
2	GL	CCFL Power Supply (low voltage)

## RECOMMENDED TRANSMITTER (DS90CF363) TO LTM10C306L INTERFACE ASSIGNMENT

## Case1: 6bit Transmitter

DS90CF363				LTM10C306L Interface (CN1)		
Input Terminal No.		Input Signal (Graphics controller output signal)		Output Signal Symbol	Terminal	Symbol
Symbol	DS90CF363	Symbol	Function			
TIN0	44	R0	Red Pixels Display Data (LSB)	TOUT0- TOUT0+	No.12 No.11	IN0- IN0+
TIN1	45	R1	Red Pixels Display Data			
TIN2	47	R2	Red Pixels Display Data			
TIN3	48	R3	Red Pixels Display Data			
TIN4	1	R4	Red Pixels Display Data			
TIN5	3	R5	Red Pixels Display Data (MSB)			
TIN6	4	G0	Green Pixels Display Data (LSB)	TOUT1- TOUT1+	No.10 No.9	IN1- IN1+
TIN7	6	G1	Green Pixels Display Data			
TIN8	7	G2	Green Pixels Display Data			
TIN9	9	G3	Green Pixels Display Data			
TIN10	10	G4	Green Pixels Display Data			
TIN11	12	G5	Green Pixels Display Data (MSB)			
TIN12	13	B0	Blue Pixels Display Data (LSB)	TOUT2- TOUT2+	No.8 No.7	IN2- IN2+
TIN13	15	B1	Blue Pixels Display Data			
TIN14	16	B2	Blue Pixels Display Data			
TIN15	18	B3	Blue Pixels Display Data			
TIN16	19	B4	Blue Pixels Display Data			
TIN17	20	B5	Blue Pixels Display Data (MSB)			
TIN18	22	NC	Non Connection (open)	TCLK OUT- TCLK OUT+	No.6 No.5	CLK IN- CLK IN+
TIN19	23	NC	Non Connection (open)			
TIN20	25	ENAB	Compound Synchronization Signal			
CLK IN	26	NCLK	Data Sampling Clock			

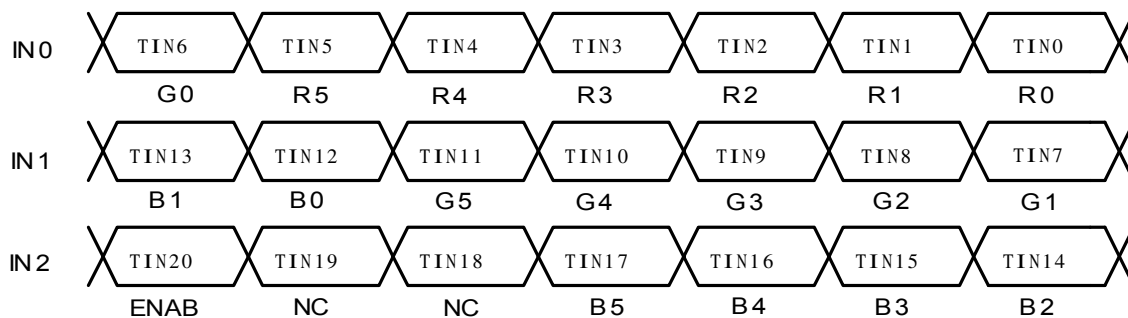

## RECOMMENDED TRANSMITTER (DS90CF383) TO LTM10C306L INTERFACE ASSIGNMENT

## Case2: 8bit Transmitter

DS90CF383				LTM10C306L Interface (CN1)		
Input Terminal No.		Input Signal (Graphics controller output signal)		Output Signal Symbol	Terminal	Symbol
Symbol	DS90CF383	Symbol	Function			
TIN0	51	R0	Red Pixels Display Data (LSB)	TOUT0- TOUT0+	No.12 No.11	IN0- IN0+
TIN1	52	R1	Red Pixels Display Data			
TIN2	54	R2	Red Pixels Display Data			
TIN3	55	R3	Red Pixels Display Data			
TIN4	56	R4	Red Pixels Display Data			
TIN6	3	R5	Red Pixels Display Data (MSB)			
TIN7	4	G0	Green Pixels Display Data(LSB)			
TIN8	6	G1	Green Pixels Display Data	TOUT1- TOUT1+	No.10 No.9	IN1- IN1+
TIN9	7	G2	Green Pixels Display Data			
TIN12	11	G3	Green Pixels Display Data			
TIN13	12	G4	Green Pixels Display Data			
TIN14	14	G5	Green Pixels Display Data(MSB)			
TIN15	15	B0	Blue Pixels Display Data (LSB)			
TIN18	19	B1	Blue Pixels Display Data			
TIN19	20	B2	Blue Pixels Display Data	TOUT2- TOUT2+	No.8 No.7	IN2- IN2+
TIN20	22	B3	Blue Pixels Display Data			
TIN21	23	B4	Blue Pixels Display Data			
TIN22	24	B5	Blue Pixels Display Data (MSB)			
TIN24	27	NC	Non Connection (open)			
TIN25	28	NC	Non Connection (open)			
TIN26	30	ENAB	Compound Synchronization Signal			
TIN27	50	NC	Non Connection (open)	TOUT3- TOUT3+		
TIN5	2	NC	Non Connection (open)			
TIN10	8	NC	Non Connection (open)			
TIN11	10	NC	Non Connection (open)			
TIN16	16	NC	Non Connection (open)			
TIN17	18	NC	Non Connection (open)			
TIN23	25	NC	Non Connection (open)			
CLK IN	31	NCLK	Data Sampling Clock	TCLK OUT- TCLK OUT+	No.6 No.5	CLK IN- CLK IN+

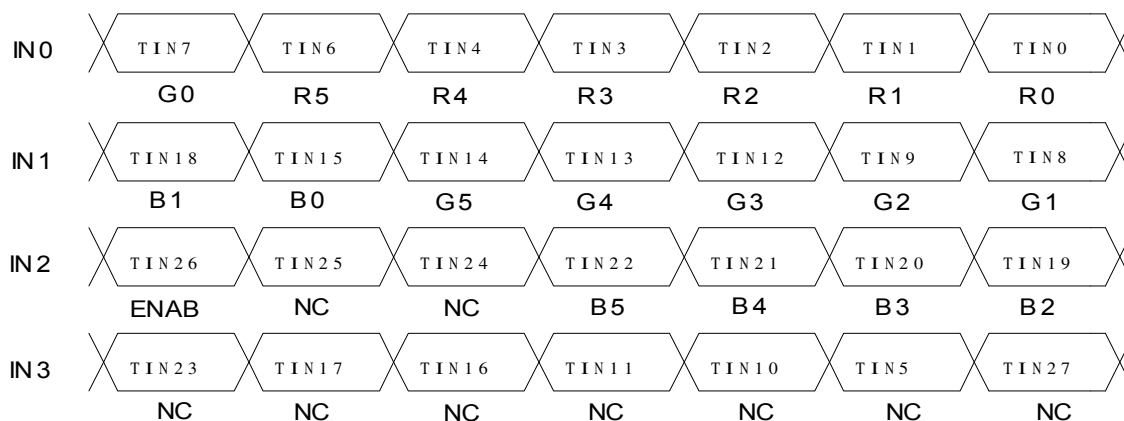



256k (k=1024) COLORS COMBINATION TABLE

	Display	R5 R4 R3 R2 R1 R0	G5 G4 G3 G2 G1 G0	B5 B4 B3 B2 B1 B0	Gray Scale Level
Basic Color	Black	L L L L L L	L L L L L L	L L L L L L	-
	Blue	L L L L L L	L L L L L L	H H H H H H	-
	Green	L L L L L L	H H H H H H	L L L L L L	-
	Light Blue	L L L L L L	H H H H H H	H H H H H H	-
	Red	H H H H H H	L L L L L L	L L L L L L	-
	Purple	H H H H H H	L L L L L L	H H H H H H	-
	Yellow	H H H H H H	H H H H H H	L L L L L L	-
	White	H H H H H H	H H H H H H	H H H H H H	-
Gray Scale of Red	Black	L L L L L L	L L L L L L	L L L L L L	L 0
	Dark ↑ ↓ Light	L L L L L H	L L L L L L	L L L L L L	L 1
		L L L L H L	L L L L L L	L L L L L L	L 2
		: :	: :	: :	L3... L60
		H H H H L H	L L L L L L	L L L L L L	L61
		H H H H H L	L L L L L L	L L L L L L	L62
	Red	H H H H H H	L L L L L L	L L L L L L	Red L63
	Gray Scale of Green	Black	L L L L L L	L L L L L L	L L L L L L
Dark ↑ ↓ Light		L L L L L L	L L L L L H	L L L L L L	L 1
		L L L L L L	L L L L H L	L L L L L L	L 2
		: :	: :	: :	L3... L60
		L L L L L L	H H H H L H	L L L L L L	L61
		L L L L L L	H H H H H L	L L L L L L	L62
Green		L L L L L L	H H H H H H	L L L L L L	Green L63
Gray Scale of Blue		Black	L L L L L L	L L L L L L	L L L L L L
	Dark ↑ ↓ Light	L L L L L L	L L L L L L	L L L L L H	L 1
		L L L L L L	L L L L L L	L L L L H L	L 2
		: :	: :	: :	L3... L60
		L L L L L L	L L L L L L	H H H H L H	L61
		L L L L L L	L L L L L L	H H H H H L	L62
	Blue	L L L L L L	L L L L L L	H H H H H H	Blue L63
	Gray Scale of White & Black	Black	L L L L L L	L L L L L L	L L L L L L
Dark ↑ ↓ Light		L L L L L H	L L L L L H	L L L L L H	L 1
		L L L L H L	L L L L H L	L L L L H L	L 2
		: :	: :	: :	L3... L60
		H H H H L H	H H H H L H	H H H H L H	L61
		H H H H H L	H H H H H L	H H H H H L	L62
White		H H H H H H	H H H H H H	H H H H H H	White L63

**FOR SAFETY**

LCD module is generally designed with precise parts to achieve light weighted thin mechanical dimensions. In using our Modules, make certain that you fully understand and put into practice the warnings and safety precautions detailed in Engineering Information No.EE-N001,"CAUTIONS AND INSTRUCTIONS FOR TOSHIBA LCD MODULES". Refer to individual specifications and TECHNICAL DATA sheets (hereinafter called "TD") for more detailed technical information.

**1) SPECIAL PURPOSES**

A) Toshiba's Standard LCD Modules have not been customized for operation in extreme environments or for use in applications where performance failures could be life-threatening or otherwise catastrophic.

B) Since Toshiba's Standard LCD Modules have not been designed for operation in extreme environments, they must never be used in devices that will be exposed to abnormally high levels of vibration or shock which exceed Toshiba's published specification limits.

C) In addition, since Toshiba Standard LCD Modules have not been designed for use in applications where performance failures could be life-threatening or catastrophic, they must never be installed in aircraft navigation control systems (such as, but not limited to Traffic Collision Avoidance System and Air Traffic Indicator), in military defense or weapons systems, in critical industrial process-control systems (e.g., those involved in the production of nuclear energy), or in critical medical device or patient life-support systems.

**2) DISASSEMBLING OR MODIFICATION**

DO NOT DISASSEMBLE OR MODIFY the module. It may damage sensitive parts inside LCD module, and may cause scratches or dust on the display.

Toshiba does not warrant the module, if customer disassembled or modified it.

**3) BREAKAGE OF LCD PANEL**

DO NOT INGEST liquid crystal material, DO NOT INHALE this material, and DO NOT CONTACT the material with skin, if LCD panel is broken and liquid crystal material spills out.

If liquid crystal material comes into mouth or eyes, rinse mouth or eyes out with water immediately.

If this material contact with skin or cloths, wash it off immediately with alcohol and rinse thoroughly with water.

**4) GLASS OF LCD PANEL**

BE CAREFUL WITH CHIPS OF GLASS that may cause injuring fingers or skin, when the glass is broken.

**5) ELECTRIC SHOCK**

DISCONNECT POWER SUPPLY before handling LCD module.

DO NOT TOUCH the parts inside LCD module and the fluorescent lamp's connector or cables in order to prevent electric shock, because high voltage is supplied to these parts from the inverter unit while power supply is turned on.

**6) ABSOLUTE MAXIMUM RATINGS AND POWER PROTECTION CIRCUIT**

DO NOT EXCEED the absolute maximum rating values under the worst probable conditions caused by the supply voltage variation, input voltage variation, variation in parts' constants, environmental temperature, etc., otherwise LCD module may be damaged.

Employ protection circuit for power supply, whenever the specification or TD specifies it.

Suitable protection circuit should be applied for each system design.

**7) DISPOSAL**

When dispose LCD module, obey to the applicable environmental regulations.