

AU OPTRONICS CORPORATION

Product Specification

19.0" SXGA Color TFT-LCD Module

Model Name: M190EN03 V.0

Approved by	Prepared by
<i>CC Chiu</i>	<i>Flossie Chuang.</i>

DDBU Marketing Division / AU Optronics

Customer	Checked & Approved by

Product Specification

19.0" SXGA Color TFT-LCD Module

Model Name: M190EN03

V.0

(◆) Preliminary Specifications

() Final Specifications

Note: This Specification is subject to change without notice.

Contents

1.0 Handling Precautions	7
2.0 General Description	8
2.1 Display Characteristics.....	8
2.2 Optical Characteristics.....	9
3.0 Functional Block Diagram	12
4.0 Absolute Maximum Ratings	13
4.1 TFT LCD Module	13
4.2 Backlight Unit.....	13
4.3 Absolute Ratings of Environment.....	13
5.0 Electrical characteristics	14
5.1 TFT LCD Module	14
5.1.1 Power Specification.....	14
5.1.2 Signal Electrical Characteristics.....	15
5.2 Backlight Unit.....	16
6.0 Signal Characteristics	17
6.1 Pixel Format Image	17
6.2 The Input Data Format.....	17
6.3 Signal Description.....	18
6.4.1 Timing Characteristics.....	19
6.4.2 Timing Diagram.....	20
6.5 Power ON/OFF Sequence	21
7.0 Connector & Pin Assignment	22
7.1 TFT LCD Module	22
7.2 Backlight Unit.....	23
7.3 Signal for Lamp Connector.....	23
8.0 Vibration, Shock, and Drop	23
8.1 Vibration & Shock.....	23
8.2 Drop Test	23
9.0 Environment	24
9.1 Temperature and Humidity.....	24
9.1.1 Operating Conditions	24
9.1.2 Shipping Conditions	24
9.2 Atmospheric Pressure.....	24
9.3 Thermal Shock.....	24
10.0 Reliability	25
10.1 Failure Criteria.....	25

10.2 Failure Rate.....	25
10.2.1 Usage.....	25
10.2.2 Component De-rating.....	25
10.3 On/OFF Cycle	25
11.0 Safety	26
11.1 Sharp Edge Requirements.....	26
11.2 Materials	26
11.2.1 Toxicity.....	26
11.2.2 Flammability.....	26
11.3 Capacitors.....	26
12.0 Other requirement	26
12.1 National Test Lab Requirement.....	26
12.2 Label.....	26
13.0 Mechanical Characteristics	27

Record of Revision

Version and Date	Page	Old description	New Description	Remark																																																																								
0.1 2004/04/05	All	First Edition for Customer	All																																																																									
0.2 2004/06/17	14	4.3 Absolute Ratings of Environment.	Add Note 3	Added																																																																								
	15	5.1.1 VDD current: Typ=TBD Max=TBD	5.1.1 VDD current: Typ=1400 mA Max=1800 mA	Modified																																																																								
	15	5.1.1 VDD Power Typ=TBD Max=8	5.1.1 VDD Power Typ= 7 Max=9	Modified																																																																								
0.3 2004/07/06	8	2.1 Display Characteristics Contrast Ratio=700:1 (Typ)	2.1 Display Characteristics Contrast Ratio=800:1 (Typ)	Modified																																																																								
	9	2.2 Optical Characteristics Contrast Ratio (Normal Direction) Min=400 Typ=700	2.2 Optical Characteristics Contrast Ratio Normal Direction Min=500 Typ=800	Modified																																																																								
	16	5.1.2 Signal Electrical Characteristics VTH/VTL= ±100MV	5.1.2 Signal Electrical Characteristics VTH/VTL = ±100mV	Modified																																																																								
	17	5.2 Backlight Unit CCFL Power Consumption Max=24	5.2 Backlight Unit CCFL Power Consumption Max=23.1	Modified																																																																								
0.4 2004/07/30	8	2.1 Display Characteristics Power consumption: 30 W(Typ) Electrical Interface: Even/Odd R/G/B data, 3 sync signal,Clock	2.1 Display Characteristics Power consumption: 28 W(Typ) Electrical Interface: Dual Channel LVDS, DE mode	Modified																																																																								
	8	2.1 Display Characteristics	2.1 Display Characteristics Surface treatment: Anti-glare, hard coating (3H)	Added																																																																								
	9	2.2 Optical Characteristics <table border="1" style="display: inline-table; vertical-align: top;"> <tr> <td>Color/</td> <td>Red x</td> <td></td> <td>0.607</td> <td>0.637</td> <td>0.667</td> </tr> <tr> <td>Chromaticity</td> <td>Red y</td> <td></td> <td>0.323</td> <td>0.353</td> <td>0.383</td> </tr> <tr> <td>Coordinates</td> <td>Green x</td> <td></td> <td>0.262</td> <td>0.292</td> <td>0.322</td> </tr> <tr> <td>(CIE)</td> <td>Green y</td> <td></td> <td>0.588</td> <td>0.618</td> <td>0.648</td> </tr> <tr> <td></td> <td>Blue x</td> <td></td> <td>0.115</td> <td>0.145</td> <td>0.175</td> </tr> <tr> <td></td> <td>Blue y</td> <td></td> <td>0.036</td> <td>0.066</td> <td>0.096</td> </tr> </table>	Color/	Red x		0.607	0.637	0.667	Chromaticity	Red y		0.323	0.353	0.383	Coordinates	Green x		0.262	0.292	0.322	(CIE)	Green y		0.588	0.618	0.648		Blue x		0.115	0.145	0.175		Blue y		0.036	0.066	0.096	2.2 Optical Characteristics <table border="1" style="display: inline-table; vertical-align: top;"> <tr> <td>Color/</td> <td>Red x</td> <td></td> <td>0.611</td> <td>0.641</td> <td>0.671</td> </tr> <tr> <td>Chromaticity</td> <td>Red y</td> <td></td> <td>0.323</td> <td>0.353</td> <td>0.383</td> </tr> <tr> <td>Coordinates</td> <td>Green x</td> <td></td> <td>0.259</td> <td>0.289</td> <td>0.319</td> </tr> <tr> <td>(CIE)</td> <td>Green y</td> <td></td> <td>0.596</td> <td>0.626</td> <td>0.656</td> </tr> <tr> <td></td> <td>Blue x</td> <td></td> <td>0.112</td> <td>0.142</td> <td>0.172</td> </tr> <tr> <td></td> <td>Blue y</td> <td></td> <td>0.048</td> <td>0.078</td> <td>0.108</td> </tr> </table>	Color/	Red x		0.611	0.641	0.671	Chromaticity	Red y		0.323	0.353	0.383	Coordinates	Green x		0.259	0.289	0.319	(CIE)	Green y		0.596	0.626	0.656		Blue x		0.112	0.142	0.172		Blue y		0.048	0.078	0.108	Modified
Color/	Red x		0.607	0.637	0.667																																																																							
Chromaticity	Red y		0.323	0.353	0.383																																																																							
Coordinates	Green x		0.262	0.292	0.322																																																																							
(CIE)	Green y		0.588	0.618	0.648																																																																							
	Blue x		0.115	0.145	0.175																																																																							
	Blue y		0.036	0.066	0.096																																																																							
Color/	Red x		0.611	0.641	0.671																																																																							
Chromaticity	Red y		0.323	0.353	0.383																																																																							
Coordinates	Green x		0.259	0.289	0.319																																																																							
(CIE)	Green y		0.596	0.626	0.656																																																																							
	Blue x		0.112	0.142	0.172																																																																							
	Blue y		0.048	0.078	0.108																																																																							
	15	5.1.1 Power Specification Irush (LCD Inrush Current) Max=7 [A]	5.1.1 Power Specification Irush (LCD Inrush Current) Max=3.5 [A]	Modified																																																																								
	17	5.2 Backlight Unit ViCFL(0°C)=1630 (Min)	5.2 Backlight Unit ViCFL(0°C)=1810 (Min)	Modified																																																																								

Product Specification

		ViCFL(25°C)=1255 (Min) VCFL = 800 @ 7.5mA (Max)	ViCFL(25°C)=1540 (Min) VCFL = 800 (Max)											
	20	6.4.1 Timing Characteristics Horizontal section Period (Th)=700(Min) Blanking (Tbp(h)+Tfp(h)+PWhs)=60(Min)	6.4.1 Timing Characteristics Horizontal section Period (Th)=720(Min) Blanking (Tbp(h)+Tfp(h)+PWhs)=80(Min) Clock Frequency = 30 (Min)	Modified										
	22	6.5 Power ON/OFF Sequence T1=0 (Min)	6.5 Power ON/OFF Sequence T1=0.5 (Min)	Modified										
	23	7.1 TFT LCD Module	<table border="1"> <tr> <td colspan="2">7.1 TFT LCD Module</td> </tr> <tr> <td>Connector Name / Designation</td> <td>Interface Connector / Interface card</td> </tr> <tr> <td>Manufacturer</td> <td>HIROSE or compatible</td> </tr> <tr> <td>Type Part Number</td> <td>MDF 76KBW-30S-1H(58)</td> </tr> <tr> <td>Mating Housing Part Number</td> <td>MDF 70G-30P-1SD</td> </tr> </table>	7.1 TFT LCD Module		Connector Name / Designation	Interface Connector / Interface card	Manufacturer	HIROSE or compatible	Type Part Number	MDF 76KBW-30S-1H(58)	Mating Housing Part Number	MDF 70G-30P-1SD	Added
7.1 TFT LCD Module														
Connector Name / Designation	Interface Connector / Interface card													
Manufacturer	HIROSE or compatible													
Type Part Number	MDF 76KBW-30S-1H(58)													
Mating Housing Part Number	MDF 70G-30P-1SD													
	30	13.0 Mechanical Characteristics	13.0 Mechanical Characteristics 10.Cable length from constrain to free end must be 130±0mm. Total cable length must be 150±0mm	Added										
0.5 2004/11/3	9	2.1 Display characteristics Optical Response Time =16ms (Typ, grey to grey)	2.1 Display characteristics Optical Response Time = 8ms GTG (Avg. Typ.)	Modified										
	10	2.2 Optical characteristics Response Time (Grey to Grey) =16ms (Typ)	2.2 Optical characteristics Response Time (Grey to Grey) =8ms (Avg. Typ) ; 16ms (Max)	Modified										
	10	2.2 Optical characteristics Luminance Uniformity (%) = 70 (Min.) ; 75 (Typ.)	2.2 Optical characteristics Luminance Uniformity (%) = 75 (Min.) ; 80 (Typ.)	Modified										
	13	4.3 Absolute Ratings of Environment Operating/Storage Humidity=95 (Max)	4.3 Absolute Ratings of Environment Operating/Storage Humidity=90 (Max)	Modified										
	17	5.2 Backlight Unit IRCFL = 3.0mA (Min.)	5.2 Backlight Unit IRCFL = 2.5mA (Min.)	Modified										
	21	6.5 Power On/Off Sequence T3 = 300 ms (Min.) T4 = 300 ms (Min.)	6.5 Power On/Off Sequence T3 = 200 ms (Min.) T4 = 200 ms (Min.)	Modified										
	30	13.0 Mechanical Characteristics 10.Cable length from constrain to free end must be 130±0mm. Total cable length must be 150±0mm	13.0 Mechanical Characteristics 10.Cable length from constrain to free end must be 140±0mm. Total cable length must be 170±0mm	Modified										

1.0 Handling Precautions

- 1) Since front polarizer is easily damaged, pay attention not to scratch it.
- 2) Be sure to turn off power supply when inserting or disconnecting from input connector.
- 3) Wipe off water drop immediately. Long contact with water may cause discoloration or spots.
- 4) When the panel surface is soiled, wipe it with absorbent cotton or other soft cloth.
- 5) Since the panel is made of glass, it may break or crack if dropped or bumped on hard surface.
- 6) Since CMOS LSI is used in this module, take care of static electricity and insure human earth when handling.
- 7) Do not open nor modify the Module Assembly.
- 8) Do not press the reflector sheet at the back of the module to any directions.
- 9) In case if a module has to be put back into the packing container slot after once it was taken out from the container, do not press the center of the CCFL reflector edge. Instead, press at the far ends of the CCFL reflector edge softly. Otherwise the TFT module may be damaged.
- 10) At the insertion or removal of the Signal Interface Connector, be sure not to rotate nor tilt the Interface Connector of the TFT module.
- 11) After installation of the TFT module into an enclosure (Desktop monitor Bezel, for example), do not twist nor bend the TFT Module even momentary. At designing the enclosure, it should be taken into consideration that no bending/twisting forces are applied to the TFT module from outside. Otherwise the TFT module may be damaged.

2.0 General Description

This specification applies to the 19.0 inch Color TFT-LCD Module M190EN03 V0.

The display supports the SXGA (1280(H) x 1024(V)) screen format and 16.7M colors (RGB 8-bits data).

All input signals are 2 Channel LVDS interface compatible.

This module does not contain an inverter card for backlight.

2.1 Display Characteristics

The following items are characteristics summary on the table under 25 °C condition:

ITEMS	Unit	SPECIFICATIONS			
Screen Diagonal	[mm]	480(19")			
Active Area	[mm]	376.32 (H) x 301.056 (V)			
Pixels H x V		1280(x3) x 1024			
Pixel Pitch	[mm]	0.294 (per one triad) x 0.294			
Pixel Arrangement		R.G.B. Vertical Stripe			
Display Mode		Normally Black			
White Luminance (Center)	[cd/m ²]	250 cd/m ² @7mA (Typ)			
Contrast Ratio		800 : 1 (Typ)			
Optical Response Time	[msec]	8ms GTG (Avg. Typ.); 20ms (Typ on/off)			
Nominal Input Voltage VDD	[Volt]	+5.0 V			
Power Consumption (VDD line + CCFL line)	[Watt]	28W(Typ) (w/o Inverter, All white pattern)			
Weight	[Grams]	2500 (Max)			
Physical Size	[mm]		Min.	Typ.	Max.
		Horizontal(H)	395.5	396	396.5
		Vertical(V)	323.5	324	324.5
		Depth(D)	17.0	17.5	18.0
Electrical Interface		Dual channel LVDS, DE mode			
Support Color		16.7M colors (RGB 8-bit data)			
Surface Treatment		Anti-glare, hard coating (3H)			
Temperature Range					
Operating	[°C]	0 to +50			
Storage (Shipping)	[°C]	-20 to +60			

2.2 Optical Characteristics

The optical characteristics are measured under stable conditions at 25°C:

Item	Unit	Conditions	Min.	Typ.	Max.	Note
Viewing Angle	[degree]	Horizontal (Right)	75	85	-	
	[degree]	CR = 10 (Left)	75	85	-	
	[degree]	Vertical (Up)	75	85	-	
	[degree]	CR = 10 (Down)	75	85	-	
Contrast ratio		Normal Direction	500	800	-	
Response time	[msec]	Grey to Grey	-	8(Avg.)	16	Note 1
Color / Chromaticity Coordinates (CIE)		Red x	0.611	0.641	0.671	
		Red y	0.323	0.353	0.383	
		Green x	0.259	0.289	0.319	
		Green y	0.596	0.626	0.656	
		Blue x	0.112	0.142	0.172	
		Blue y	0.048	0.078	0.108	
Color Coordinates (CIE) White		White x	0.283	0.313	0.343	
		White y	0.299	0.329	0.359	
White Luminance at CCFL 7.0mA (central point)	[cd/m ²]		200	250	-	
Luminance Uniformity	[%]		75	80	-	Note 2
Crosstalk (in75Hz)	[%]				1.5	Note 3
Flicker	dB				-20	Note 4

Equipment Pattern Generator, Power Supply, Digital Voltmeter, Luminance meter (PR 880, BM-5A , BM 7 ,CS-1000, & EZContrast*)

Aperture 1° with 100cm VD or 2° with 50cm viewing distance

Test Point Center (VESA point 9)

Environment < 1 lux

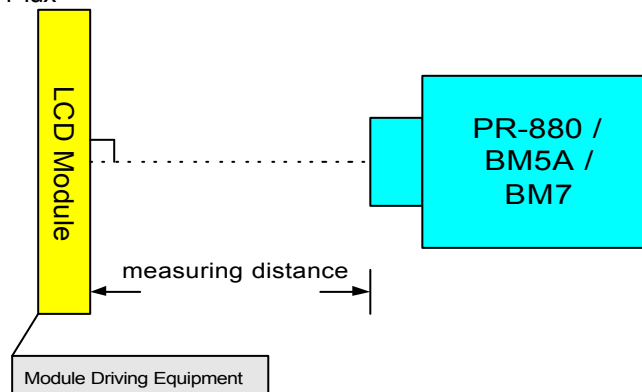

*' EZ Contrast is different measurement tool with very close viewing distance.

Note1: Definition of Response time:

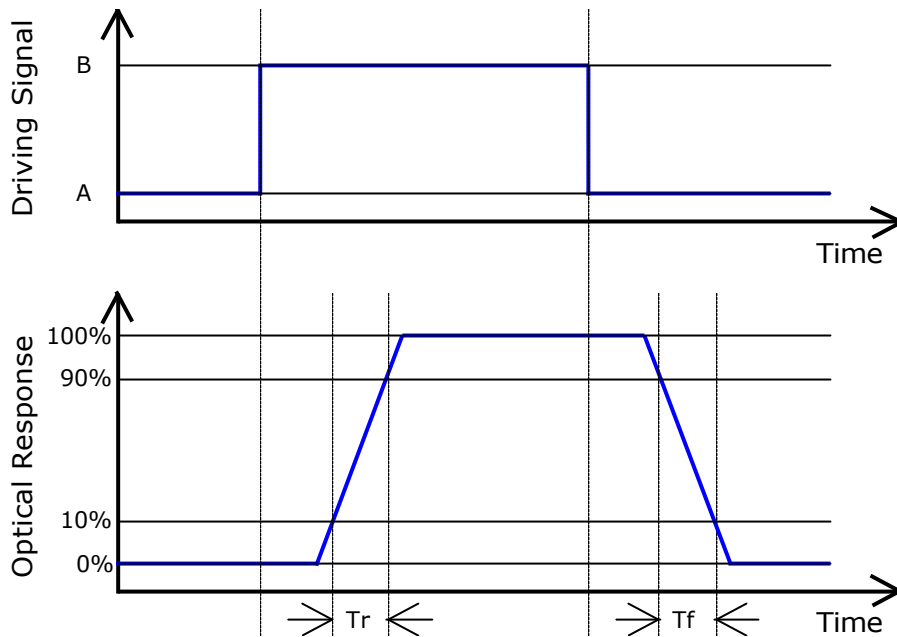

Algorithm:

$| \text{Level A} - \text{Level B} | \geq 16$ then the average of Grey-to-Grey response time is 8ms. (F = 60 Hz).

T_{rR} (rising time; from “Black” to “White”) + T_{rF} (Falling time; from “White” to “Black”) = 20ms(typ).

Note2: Brightness uniformity of these 9 points is defined as below

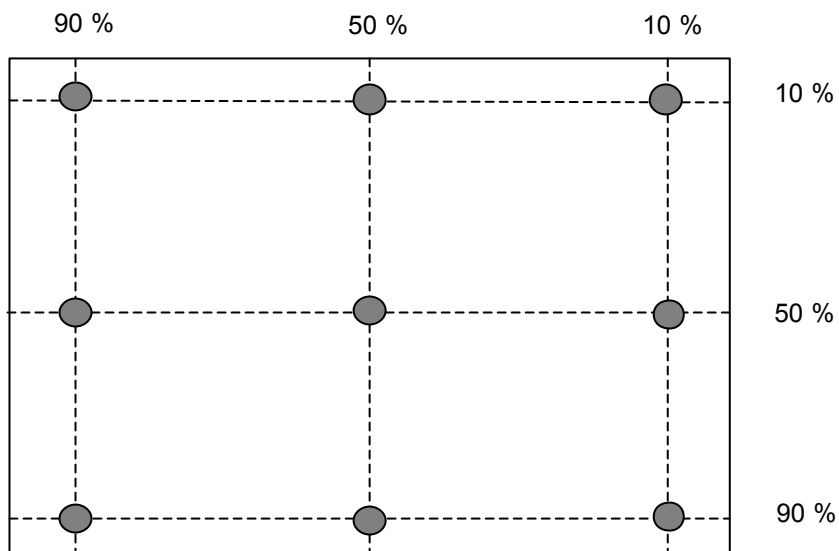

$$\text{Uniformity} = \frac{\text{Minimum Luminance in 9 points (1-9)}}{\text{Maximum Luminance in 9 Points (1-9)}}$$

Note 3: Crosstalk is defined as below :

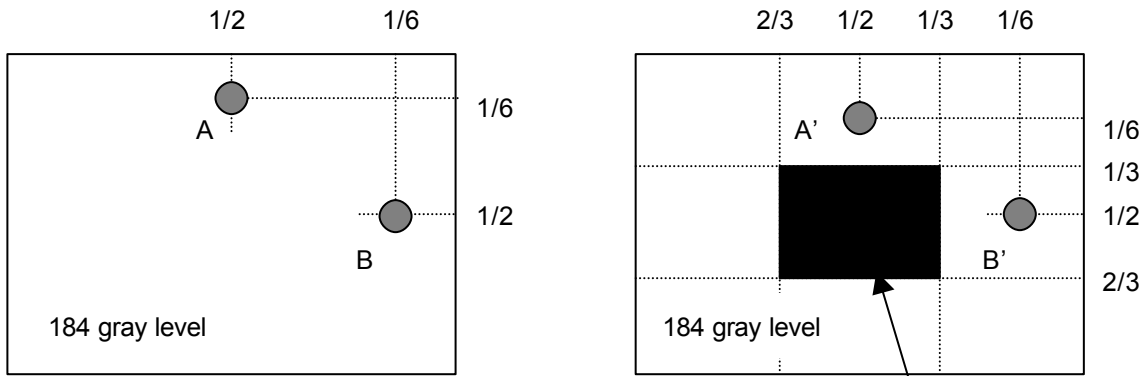

Unit: percentage of dimension of display area

$|L_A - L_{A'}| / L_A \times 100\% = 1.5\% \text{ max.}$, L_A and L_B are brightness at location A and B

$|L_{B'} - L_B| / L_B \times 100\% = 1.5\% \text{ max.}$, $L_{A'}$ and $L_{B'}$ are brightness at location A' and B'

Note 4: Test Patern: Subchecker Pattern

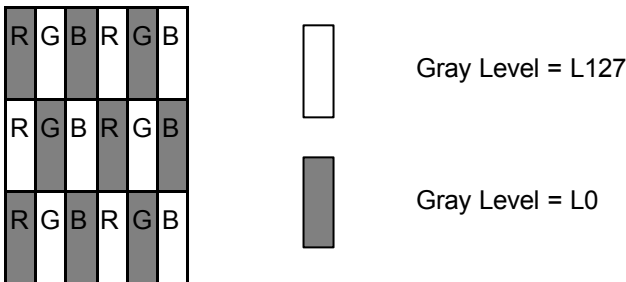

Method: Record dBV & DC value with (WESTAR)TRD-100

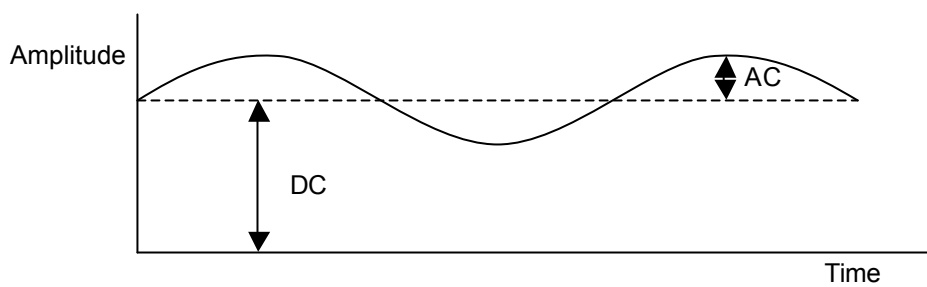

$$\text{Flicker (dB)} = 20 \log \frac{\text{AC Level(at 30 Hz)}}{\text{DC Level}}$$

3.0 Functional Block Diagram

The following diagram shows the functional block of the 19.0 inches wide Color TFT/LCD Module:

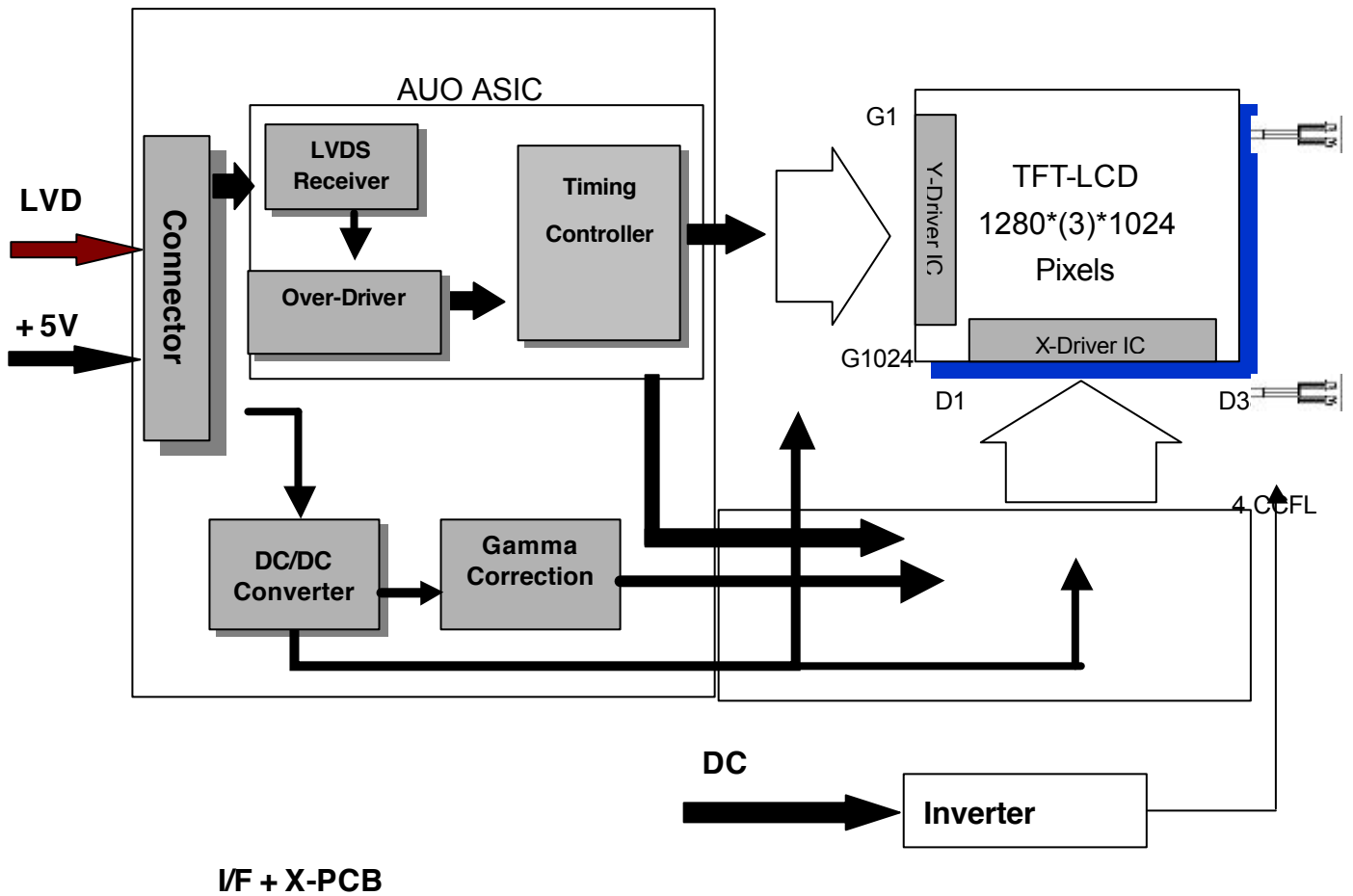

HIROSE MDF76KBW-30S-1H(58)

JST BHSR-02VS-1

Mating Type:

HIROSE MDF 76G-30P-1SD

Mating Type:

SM02B-BHSS-1-TB

4.0 Absolute Maximum Ratings

Absolute maximum ratings of the module is as following:

4.1 TFT LCD Module

Item	Symbol	Min	Max	Unit	Conditions
Logic/LCD Drive Voltage	VIN	-0.3	+5.5	[Volt]	Note 1,2

4.2 Backlight Unit

Item	Symbol	Min	Max	Unit	Conditions
CCFL Current	ICFL	-	7.5	[mA] rms	Note 1,2

4.3 Absolute Ratings of Environment

Item	Symbol	Min	Max	Unit	Conditions
Operating Humidity	HOP	8	90	[%RH]	Note 3
Storage Temperature	TST	-20	+60	[°C]	Note 3
Storage Humidity	HST	8	90	[%RH]	Note 3

Note 1: With in Ta (25°C)

Note 2: Permanent damage to the device may occur if exceed maximum values

Note 3: For quality performance, please refer to AUO IIS(Incoming Inspection Standard).

Relative Humidity %

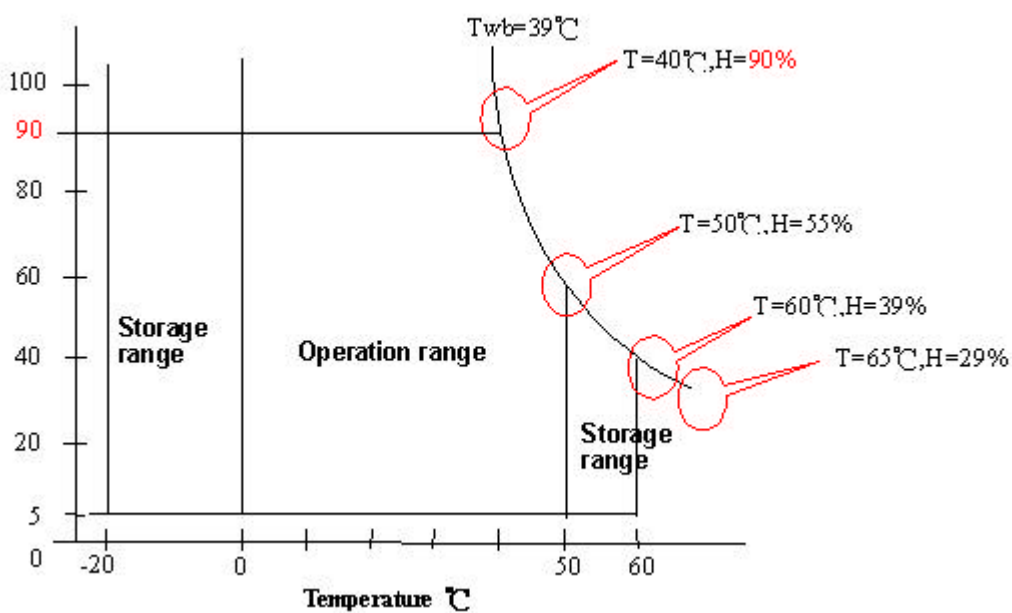

5.0 Electrical characteristics

5.1 TFT LCD Module

5.1.1 Power Specification

Input power specifications are as follows;

Symbol	Parameter	Min	Typ	Max	Units	Condition
VDD	Logic/LCD Drive Voltage	4.5	5	5.5	[Volt]	± 10%
IDD	VDD current	-	1400	1800	[mA]	Vin=5V , All White Pattern, +30%, at 75Hz
Irush	LCD Inrush Current	-	-	3.5	[A]	Note
PDD	VDD Power	-	7	9	[Watt]	Vin=5V , All White Pattern, +30%, at 75Hz
VDDrp	Allowable Logic/LCD Drive Ripple Voltage			100	[mV] p-p	
VDDns	Allowable Logic/LCD Drive Ripple Voltage			100	[mV] p-p	

Note: Measurement conditions:

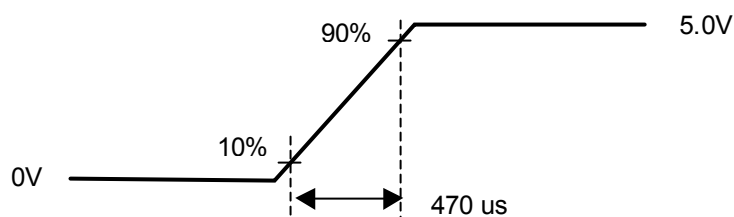
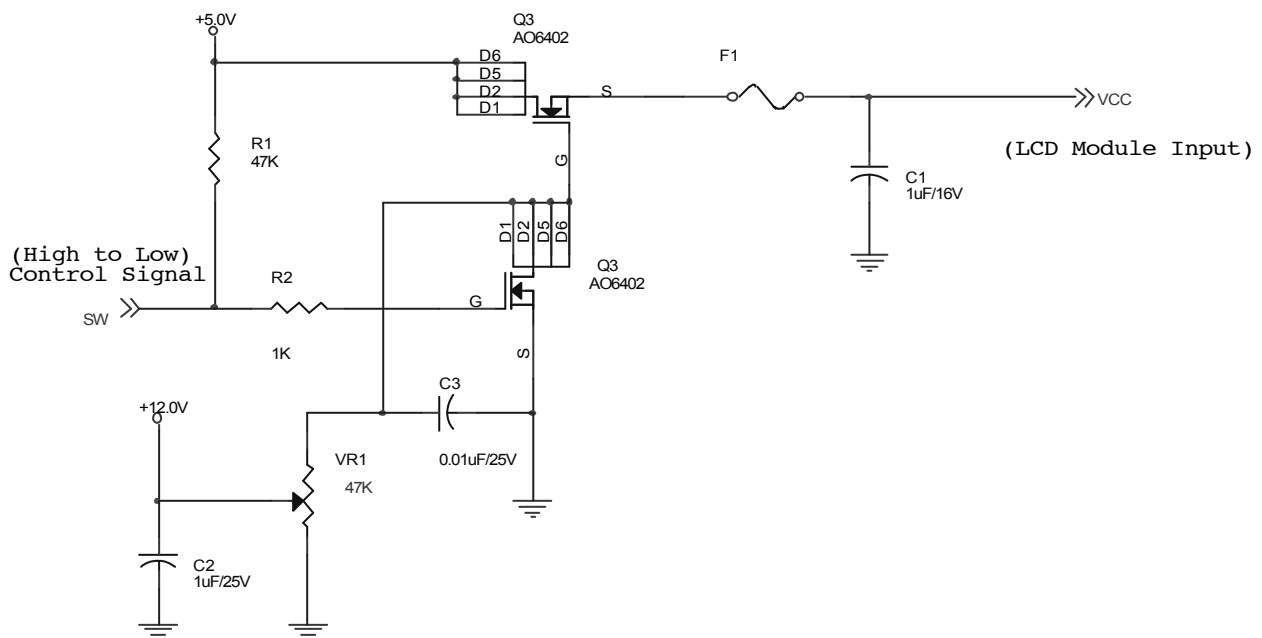

Vin rising time

5.1.2 Signal Electrical Characteristics

Input signals shall be low or Hi-Z state when Vin is off

It is recommended to refer the specifications of SN75LVDS82DGG (Texas Instruments) in detail.

Each signal characteristics are as follows;

Symbol	Parameter	Min	Typ	Max	Units	Condition
VTH	Differential Input High Threshold	-	-	+100	[mV]	VICM = 1.2V Note
VTL	Differential Input Low Threshold	-100	-	-	[mV]	VICM = 1.2V Note
VID	Input Differential Voltage	100	400	600	[mV]	Note
VICM	Differential Input Common Mode Voltage	+1.0	+1.2	+1.35	[V]	VTH/VTL = ± 100 mV Note

Note: LVDS Signal Waveform

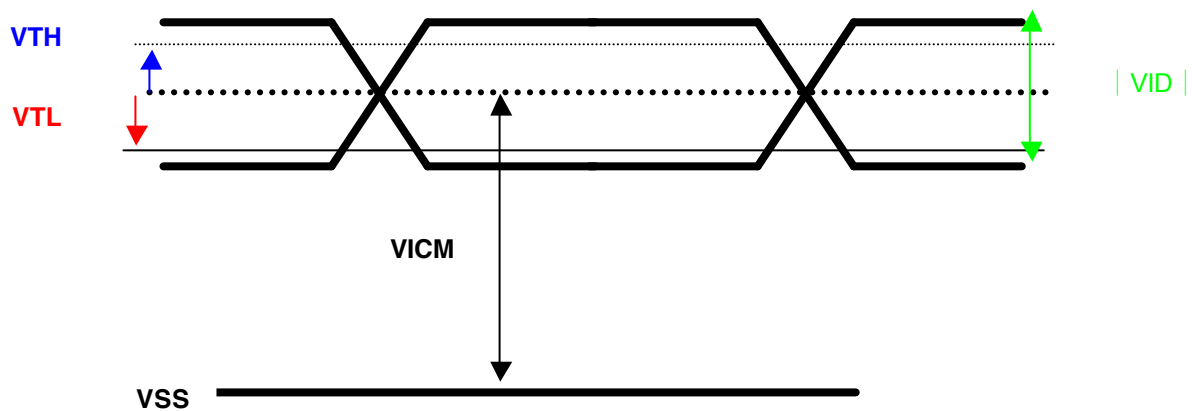

5.2 Backlight Unit

Parameter guideline for CCFL Inverter

Symbol	Parameter	Min.	Typ.	Max.	Unit	Condition
ISCFL	CCFL standard current	6.5	7.0	7.5	[mA] rms	(Ta=25°C) Note 1
IRCFL	CCFL operation range	2.5	7.0	7.5	[mA] rms	(Ta=25°C)
FCFL	CCFL Frequency	40	50	60	[KHz]	(Ta=25°C) Note 2
ViCFL (0°C)	CCFL Ignition Voltage (End of the lamp wire connector)	1810	-	-	[Volt] rms	(Ta=0°C) Note 3
ViCF (25°C)	CCFL Ignition Voltage (End of the lamp wire connector)	1540	-	-	[Volt] rms	(Ta=25°C) Note 3
VCFL	CCFL Operation Voltage	-	750 @7mA	800	[Volt] rms	(Ta=25°C) Note 4
PCFL	CCFL Power consumption (for reference)	-	21	23.1	[Watt]	(Ta=25°C) Note 5
LTCFL	CCFL life Time	40,000	50,000	-	[Hour]	(Ta=25°C) Note 6

Note 1: CCFL standard current is measured at 25±2°C.

Note 2: CCFL Frequency should be carefully determined to avoid interference between inverter and TFT LCD

Note 3: ViCFL means Ignition Voltage for both ends of the lamp, and CCFL inverter should be able to give out a power that has a generating capacity of over 1810 voltage. Lamp units need 1810 voltage minimum for ignition

Note 4: CCFL operation voltage is measured at 25±2°C.

Note 5: The variance of CCFL power consumption is ± 10%. Calculator value for reference (ICFL×VCFL×4=PCFL).

Note 6: Definition of life: brightness becomes 50% or less than the minimum luminance value of CCFL..The typical life time of CCFL is on the condition at 7.0mA lamp current.

6.0 Signal Characteristic

6.1 Pixel Format Image

Following figure shows the relationship of the input signals and LCD pixel format.

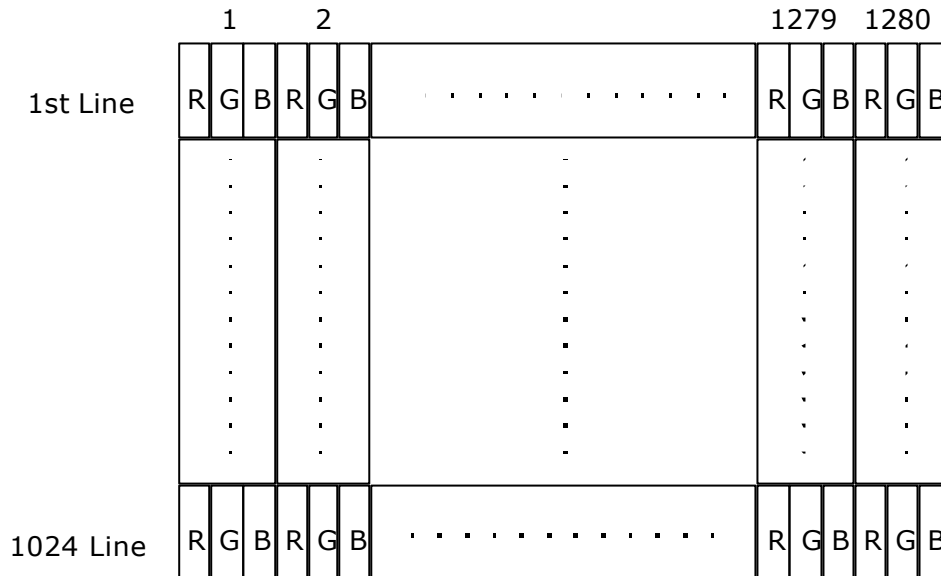

6.2 The input data format

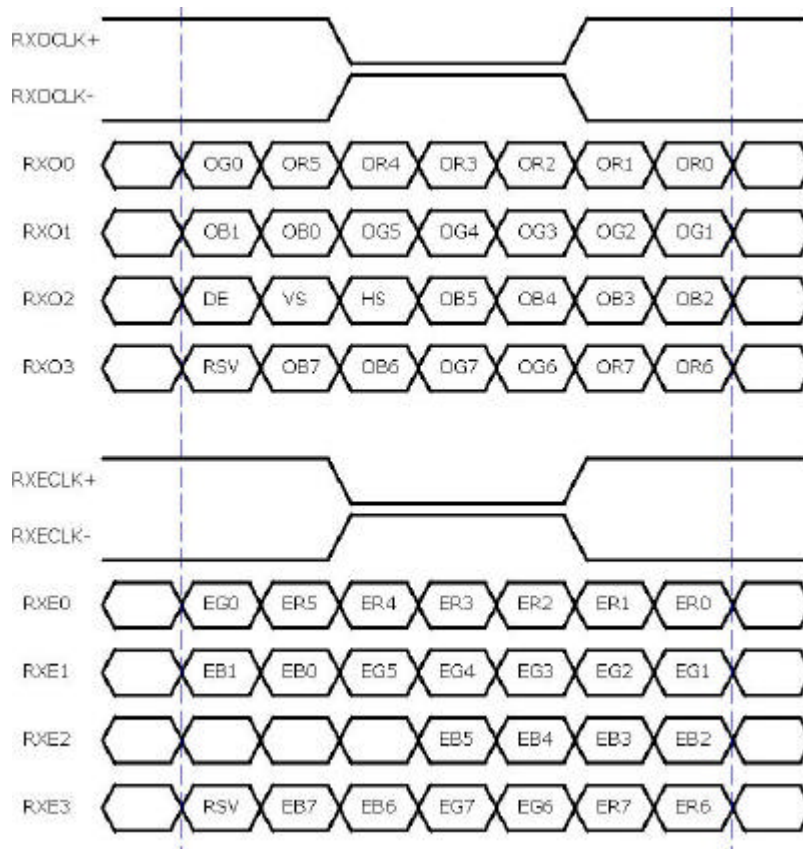

Note 1: R/G/B data 7:MSB, R/G/B data 0:LSB
 O = "First Pixel Data"
 E = "Second Pixel Data"

6.3 Signal Description

The module using one LVDS receiver SN75LVDS82(Texas Instruments) or compatible. LVDS is a differential signal technology for LCD interface and high speed data transfer device. Transmitter shall be SN75LVDS83(negative edge sampling) or compatible. The first LVDS port(RxOxxx) transmits odd pixels while the second LVDS port(RxExxx) transmits even pixels.

PIN #	SIGNAL NAME	DESCRIPTION
1	RxOIN0-	Negative LVDS differential data input (Odd data)
2	RxOIN0+	Positive LVDS differential data input (Odd data)
3	RxOIN1-	Negative LVDS differential data input (Odd data)
4	RxOIN1+	Positive LVDS differential data input (Odd data)
5	RxOIN2-	Negative LVDS differential data input (Odd data, H-Sync,V-Sync,DSPTMG)
6	RxOIN2+	Positive LVDS differential data input (Odd data, H-Sync,V-Sync,DSPTMG)
7	VSS	Power Ground
8	RxOCLKIN-	Negative LVDS differential clock input (Odd clock)
9	RxOCLKIN+	Positive LVDS differential clock input (Odd clock)
10	RxOIN3-	Negative LVDS differential data input (Odd data)
11	RxOIN3+	Positive LVDS differential data input (Odd data)
12	RxEIN0-	Negative LVDS differential data input (Even clock)
13	RxEIN0+	Positive LVDS differential data input (Even data)
14	VSS	Power Ground
15	RxEIN1-	Positive LVDS differential data input (Even data)
16	RxEIN1+	Negative LVDS differential data input (Even data)
17	VSS	Power Ground
18	RxEIN2-	Negative LVDS differential data input (Even data)
19	RxEIN2+	Positive LVDS differential data input (Even data)
20	RxECLKIN-	Negative LVDS differential clock input (Even clock)
21	RxECLKIN+	Positive LVDS differential clock input (Even clock)
22	RxEIN3-	Negative LVDS differential data input (Even data)
23	RxEIN3+	Positive LVDS differential data input (Even data)
24	VSS	Power Ground
25	NC	-
26	NC	-
27	NC	-
28	VCC	+5.0V Power Supply
29	VCC	+5.0V Power Supply
30	VCC	+5.0V Power Supply

Note1: Start from left side

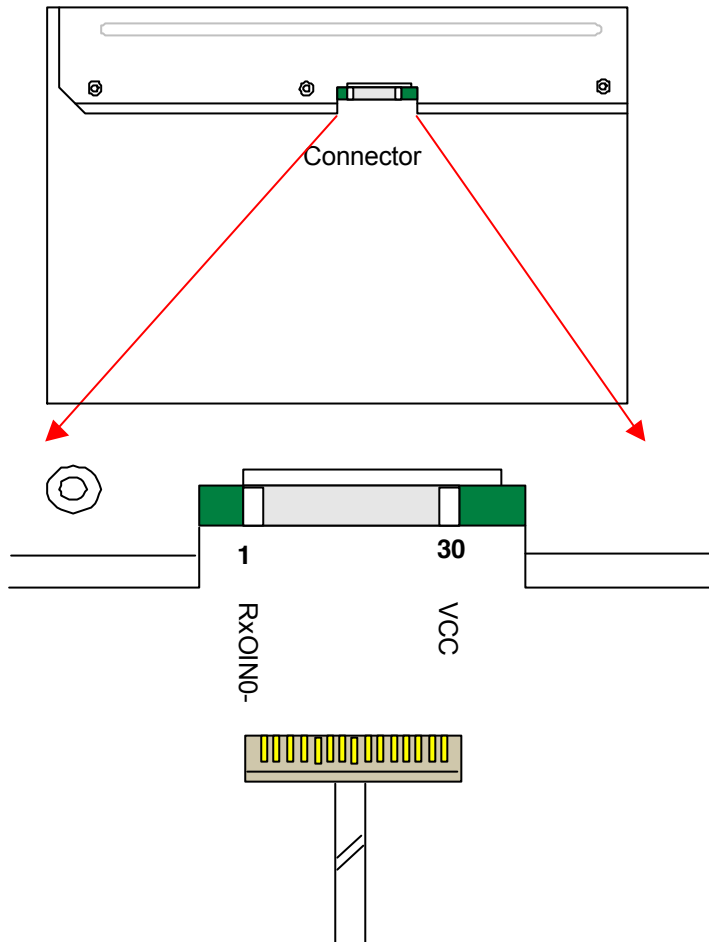

Note2: Input signals of odd and even clock shall be the same timing.

6.4.1 Timing Characteristics

Basically, interface timings described here is not actual input timing of LCD module but output timing of SN75LVDS82DGG (Texas Instruments) or equivalent.

Signal	Item	Symbol	Min	Typ	Max	Unit
Vertical Section	Period	T_v	1035	-	2048	Th
	Active	$T_{disp(v)}$	1024	1024	1024	Th
	Blanking	$T_{bp(v)}+T_{fp(v)}+PW_{vs}$	11	-	1024	Th
Horizontal Section	Period	T_h	720	-	1024	Tclk
	Active	$T_{disp(h)}$	640	640	640	Tclk
	Blanking	$T_{bp(h)}+T_{fp(h)}+PW_{hs}$	80	-	384	Tclk
Clock	Period	T_{clk}	12	-	-	ns
	Frequency	Freq	30	-	83	MHz
Frame Rate	Frequency	F	50	60	75	Hz

Note : DE mode only

6.4.2 Timing diagram

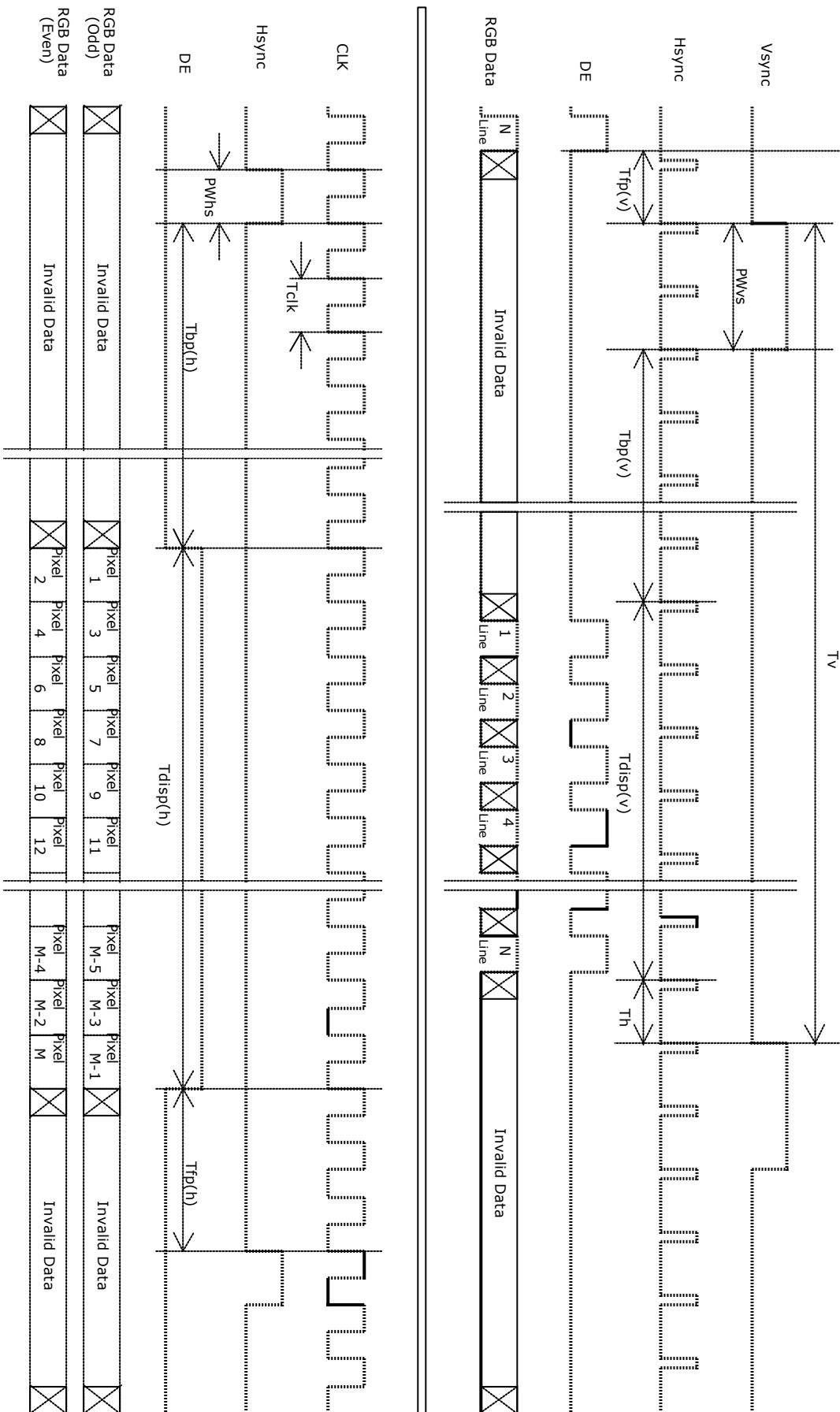

6.5 Power ON/OFF Sequence

Vin power and lamp on/off sequence is as follows. Interface signals are also shown in the chart. Signals from any system shall be Hi-Z state or low level when Vin is off.

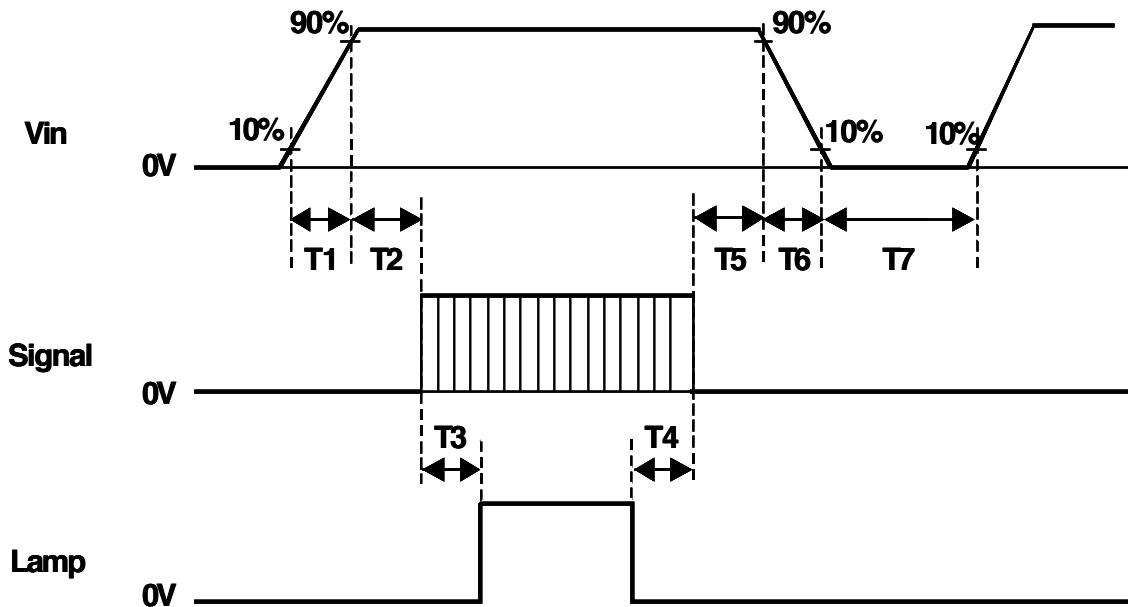

Symbol	Values			Unit
	Min	Typ	Max	
T1	0.5	-	10	[ms]
T2	0.5	40	50	[ms]
T3	200	-	-	[ms]
T4	200	-	-	[ms]
T5	0.5	16	50	[ms]
T6	0.5	-	10	[ms]
T7	1000	-	-	[ms]

7.0 Connector & Pin Assignment

Physical interface is described as for the connector on module.

These connectors are capable of accommodating the following signals and will be following components.

7.1 TFT LCD Module

Connector Name / Designation	Interface Connector / Interface card
Manufacturer	HIROSE or compatible
Type Part Number	MDF 76KBW-30S-1H(58)
Mating Housing Part Number	MDF 70G-30P-1SD

Connector Name / Designation	Interface Connector / Interface card
Manufacturer	JAE or compatible
Type Part Number	FI-XB30SL-HF10
Mating Housing Part Number	FI-X30HL-T (Locked Type) FI-X30S-H (Unlocked Type)

Pin#	Signal Name	Pin#	Signal Name
1	RxOIN0-	2	RxOIN0+
3	RxOIN1-	4	RxOIN1+
5	RxOIN2-	6	RxOIN2+
7	VSS	8	RxOCLKIN-
9	RxOCLKIN+	10	RxOIN3-
11	RxOIN3+	12	RxEIN0-
13	RxEIN0+	14	VSS
15	RxEIN1-	16	RxEIN1+
17	VSS	18	RxEIN2-
19	RxEIN2+	20	RxECLKIN-
21	RxECLKIN+	22	RxEIN3-
23	RxEIN3+	24	VSS
25	NC	26	NC
27	NC	28	VCC
29	VCC	30	VCC

7.2 Backlight Unit

Connector Name / Designation	Lamp Connector / Backlight lamp
Manufacturer	JST
Type Part Number	BHSR-02VS-1
Mating Type Part Number	SM02B-BHSS-1-TB

7.3 Signal for Lamp connector

	Connector No.	Pin No.	Input	Color	Function
Upper	CN1	1	Hot1	Pink	High Voltage
		2	Cold1	White	Low Voltage
	CN2	1	Hot2	Blue	High Voltage
		2	Cold2	Black	Low Voltage
Lower	CN3	1	Hot1	Pink	High Voltage
		2	Cold1	White	Low Voltage
	CN4	1	Hot2	Blue	High Voltage
		2	Cold2	Black	Low Voltage

8.0 Vibration, Shock, and Drop

8.1 Vibration & Shock

Vibration Test Spec:

- Frequency: 10 - 200Hz
- Sweep: 30 Minutes each Axis (X, Y, Z)
- Acceleration: 1.5G(10~200Hz P- P)
- Test method:

Acceleration (G)	1.5
Frequency (Hz)	10~200~10
Active time (min)	30

Shock Test Spec:

Acceleration (G) -a	50
Active time -b	20 ms
Wave form	Half-sin
Times	1

- Direction: ㄨ, ㄩ, ㄗ

8.2 Drop test

Package test: The drop height is 60cm.

9.0 Environment

The display module will meet the provision of this specification during operating condition or after storage or shipment condition specified below. Operation at 10% beyond the specified range will not cause physical damage to the unit.

9.1 Temperature and Humidity

9.1.1 Operating Conditions

The display module operates error free, when operated under the following conditions;

Temperature	0 °C to 50 °C
Relative Humidity	8% to 95%
Wet Bulb Temperature	39.0 °C

9.1.2 Shipping Conditions

The display module operates error free, after the following conditions;

Temperature	-20 °C to 60 °C
Relative Humidity	8% to 95%
Wet Bulb Temperature	39.0 °C

9.2 Atmospheric Pressure

The display assembly is capable of being operated without affecting its operations over the pressure range as following specified;

	Pressure	Note
Maximum Pressure	1040hPa	0m = sea level
Minimum Pressure	674hPa	3048m = 10.000 feet

Note : Non-operation attitude limit of this display module = 30,000 feet. = 9145 m.

9.3 Thermal Shock

The display module will not sustain damage after being subjected to 100 cycles of rapid temperature change. A cycle of rapid temperature change consists of varying the temperature from -20°C to 60°C, and back again.

Thermal shock cycle	-20 °C for 30min
	60 °C for 30min

Power is not applied during the test. After temperature cycling, the unit is placed in normal room ambient for at least 4 hours before powering on.

10.0 Reliability

This display module and the packaging of that will comply following standards.

10.1 Failure Criteria

The display assembly will be considered as failing unit when it no longer meets any of the requirements stated in this specification. Only as for maximum white luminance, following criteria is applicable.

- **Maximum white Luminance shall be 125cd/m² or more.**

10.2 Failure Rate

The average failure rate of the display module (from first power-on cycle till 1,000 hours later) will not exceed 1.0%. The average failure rate of the display module from 1,000 hours until 16,000 hours will not exceed 0.7% per 1000 hours.

10.2.1 Usage

The assumed usage for the above criteria is:

- 220 power-on hours per month
- 500 power on/off cycles per month
- Maximum brightness setting
- Operation to be within office environment (25°C typical)

10.2.2 Component De-rating

All the components used in this device will be checked the load condition to meet the failure rate criteria.

10.3 On/OFF Cycle

The display module will be capable of being operated over the following ON/OFF Cycles.

ON/OFF	Value	Cycles
+Vin and CCFL power	30,000	10 seconds on / 10 seconds off

11.0 Safety

11.1 Sharp Edge Requirements

There will be no sharp edges or comers on the display assembly that could cause injury.

11.2 Materials

11.2.1 Toxicity

There will be no carcinogenic materials used anywhere in the display module. If toxic materials are used, they will be reviewed and approved by the responsible AUO Toxicologist.

11.2.2 Flammability

All components including electrical components that do not meet the flammability grade UL94-V1 in the module will complete the flammability rating exception approval process.

The printed circuit board will be made from material rated 94-V1 or better. The actual UL flammability rating will be printed on the printed circuit board.

11.3 Capacitors

If any polarized capacitors are used in the display assembly, provisions will be made to keep them from being inserted backwards.

12.0 Other requirement

12.1 National Test Lab Requirement

The display module will satisfy all requirements for compliance to

UL 1950, First Edition
CSA C22.2 No.950-M89
EEC 950
EN 60 950

U.S.A. Information Technology Equipment
 Canada, Information Technology Equipment
 International, Information Technology Equipment
 International, Information Processing Equipment
 (European Norm for IEC950)

12.2 Label

The label is on the panel as shown below:

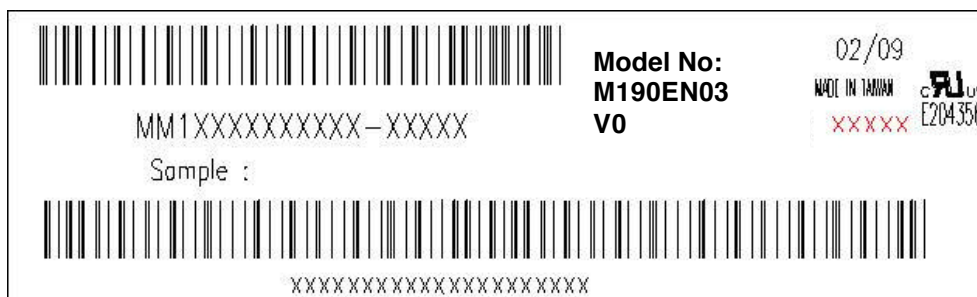

13.0 Mechanical Characteristics

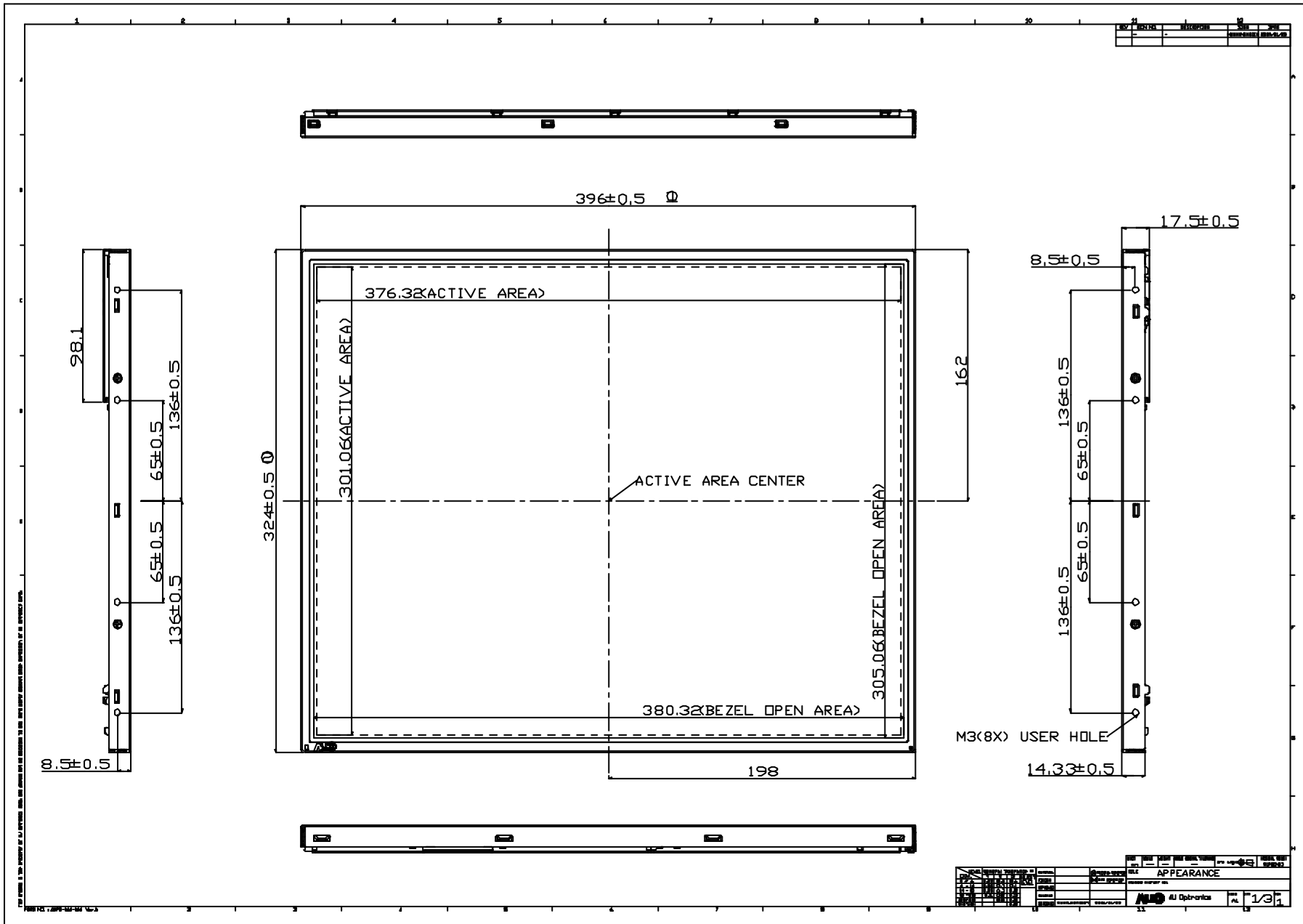

REV	DETAIL	DESCRIPTION	DATE	BY
1				

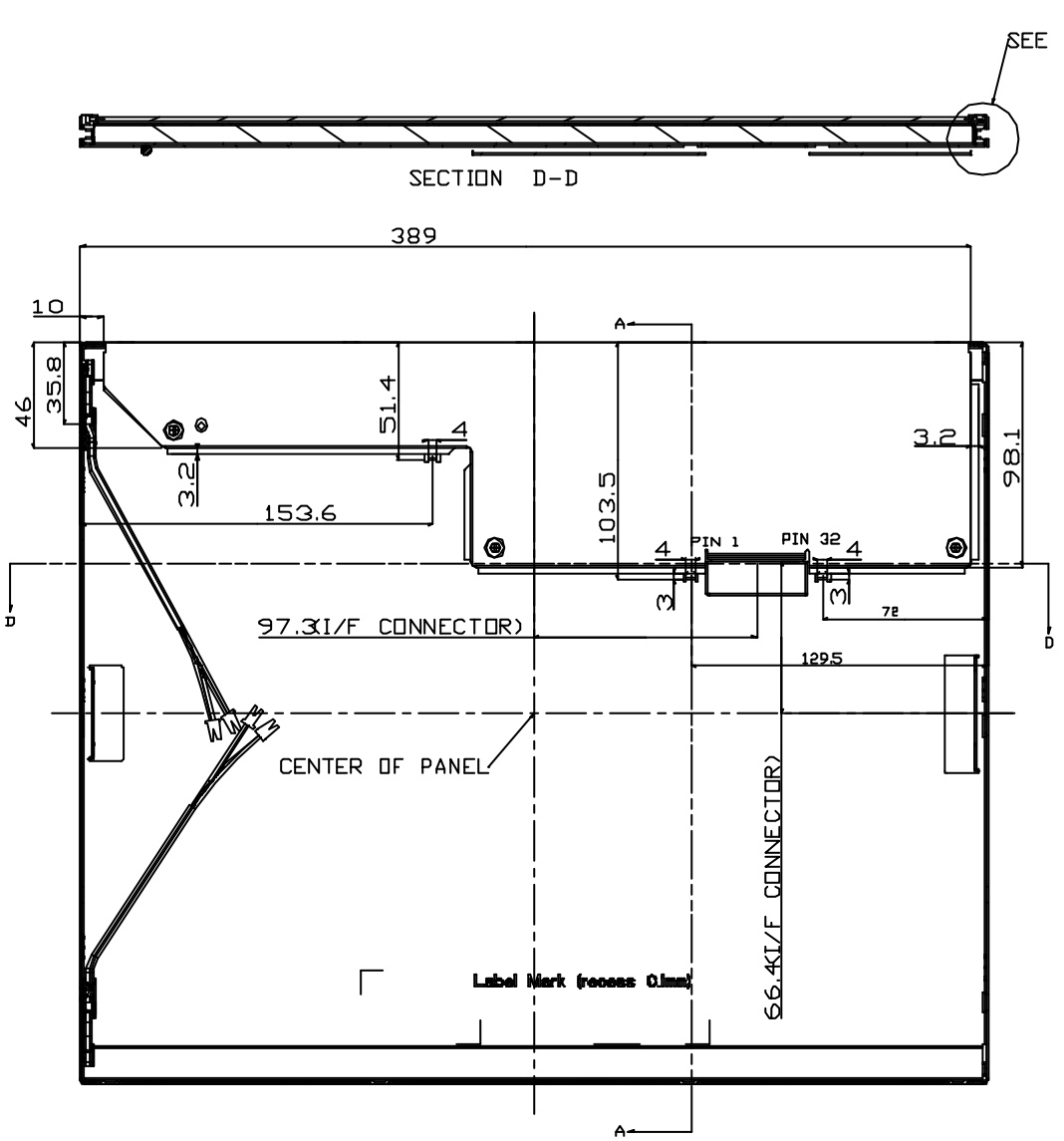

SEE DETAIL 2

DEPTH OF USER HOLE
(THE SAME AS THE OTHERS)

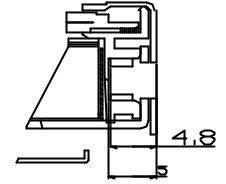

DETAIL 2
SCALE 4.000

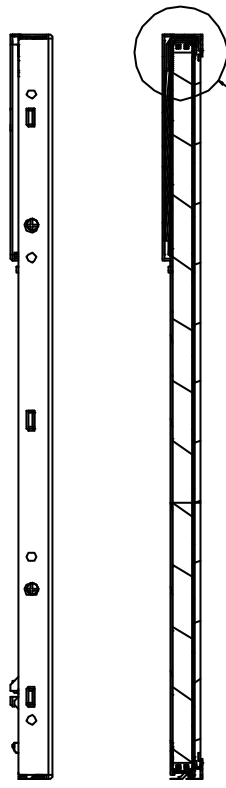

SEE DETAIL 1

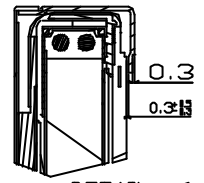

DETAIL 1
SCALE 3.000

SECTION A-A

This drawing is the property of All Optonics, Inc. and shall not be released to any third party without the written permission of All Optonics, Inc.

REV	DESCRIPTION	DATE	BY	CHKD	APP'D
1	APPEARANCE				

PROJECT: **APPEARANCE**
 DRAWING NO: **2/3**
 ALL OPTONICS, INC.

REV	REVISION	DATE	BY

NOTE:

1. PRELIMINARY DRAWING FOR REFERENCE ONLY.
2. THE DIMENSION EXCLUDES DEFORMATION.
3. MODULE THICKNESS SHOULD BE 18mm MAX.
4. TOLERANCE WITHOUT NOTICED TO BE ± 0.5 mm.
5. LAMP CABLE CONNECTOR TO BE JST BHSR-02VS-1
6. I/F CONNECTOR TO BE JAE FI-XB30SL-HF10.
7. M3 USER HOLE SCREW TORQUE 4.0kg-cm MAX.
8. USER HOLE SCREW PENETRATION 4.5mm MAX.
9. DIMENSION TOLERANCE, ABSOLUTE VALUES OF A-B AND C-D MAX MUST BE 1.0
10. CABLE LENGTH FROM CONSTRAIN TO FREE END MUST BE 140 ± 10 mm
TOTAL CABLE LENGTH MUST BE 170 ± 10 mm

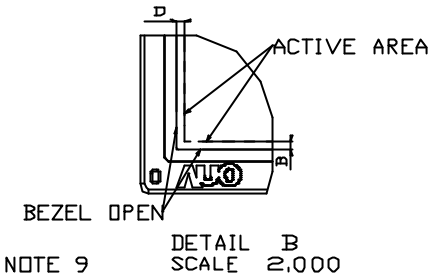
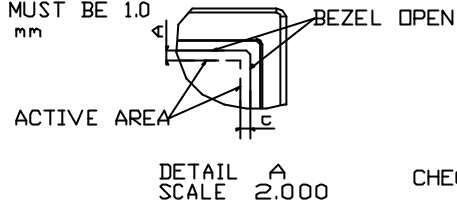

CHECK NOTE 9

THICKNESS 18mm MAX THIS AREA

SEE DETAIL A

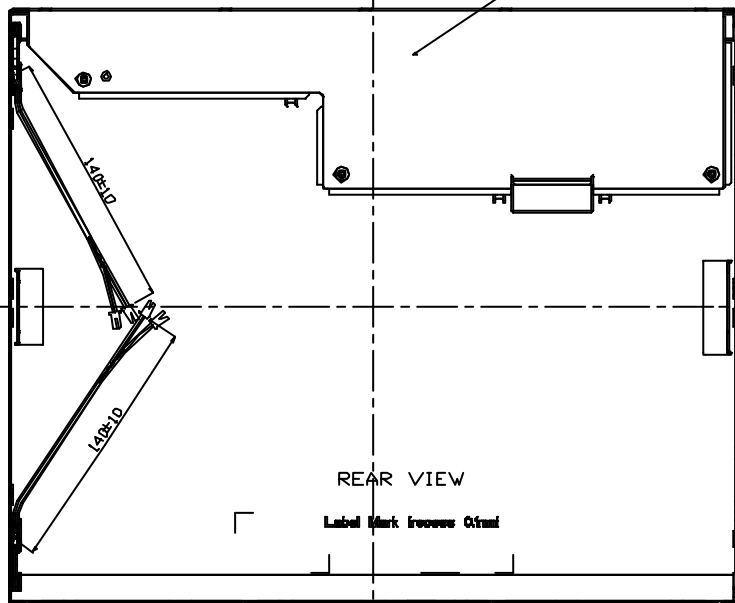

SCALE 0.800

SEE DETAIL B

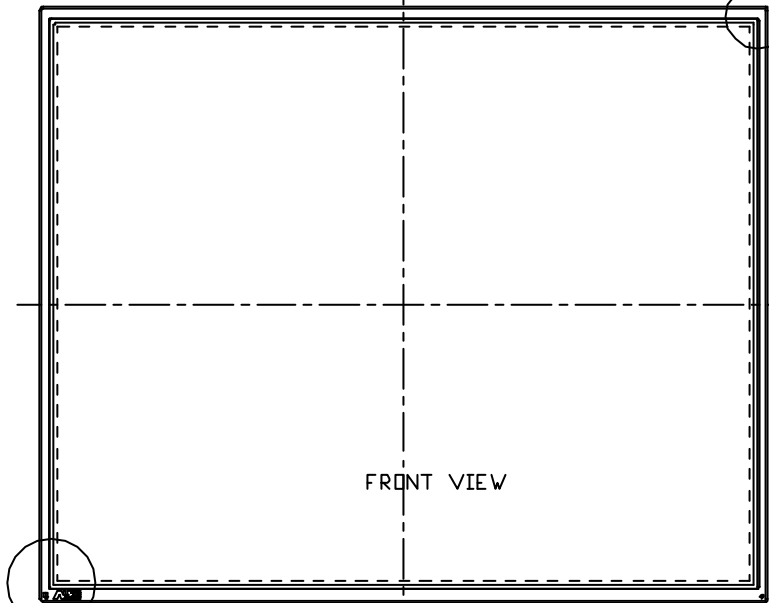

SCALE 0.800

This drawing is the property of All Optronics Inc. and shall not be released to any third party without prior written permission of All Optronics Inc.

DATE	REV	BY	CHKD	APP'D	DESCRIPTION

PROJECT					

