



## ENGINEERING SPECIFICATIONS

TFT COLOR LCD MODULE

### **TM150XG-A01-01**

- 38cm (15.0 inch) diagonal
- XGA resolution (1024 × RGB × 768 dots)
- Wide View Angle
- LVDS Interface
- Side mount
- Narrow Bezel
- With CFL backlight unit
- Nonglare surface type

**(TENTATIVE)**

Ver.2

Oct. 20, 2003

SANYO Electric Co., Ltd.  
Display Company  
Technology Engineering Business Unit

3-201, Minami-yoshikata, Tottori, 680-8634 Japan  
TEL: 81-857-21-2941, 1958  
FAX: 81-857-21-2265

**NOTICES**

1. The contents stated in this document and the product may be subject to change without prior notice. When you kindly study to use this product, please ask our distributor or us for the latest information.
2. This product is developed and produced for usage onto normal electronic products (office automation equipments, communication peripherals, electric appliance products, game machines, etc.) and is not suitable for applications which need extremely high reliability and extreme safety (aero- or space-use machines, control equipments for nuclear power, life keeping equipments, etc.).
3. This document shall not grant or guarantee any right to adapt intellectual property or any other patents of third party.
4. Please use this product correctly according to operating conditions and precautions for use stated in this document.  
Please install safety proof in your designing to avoid human accident, fire accident and social damage, which may be resulted from malfunction of this product.
5. This product is not designed to withstand against radiant rays.
6. It is strictly prohibited to copy or publish a part or whole of this document without our prior written approval.

**REVISION HISTORY**

DATE	REVISION NO.	PAGE	DESCRIPTIONS
Aug. 18, 03	Ver.1	-	Initial Release.
Oct. 20, 03	Ver.2	2	MECHANICAL CHARACTERISTICS
		3	ELECTRICAL CHARACTERISTICS
		4	OPTICAL CHARACTERISTICS
		8	BACKLIGHT CHARACTERISTICS
			INTERNAL SIGNAL TIMING PARAMETERS(DE_MODE)

## MECHANICAL CHARACTERISTICS

Ta=25 °C

ITEM	SPECIFICATION	UNIT
LCD module size	321(W) × 245.4(H) × 9.7 typ.(T)	mm
Resolution	1024 × RGB(W) × 768(H)	pixel
Sub pixel pitch	0.099(W) × 0.297(H)	mm
Pixel pitch	0.297(W) × 0.297(H)	mm
Active viewing area	304.1(W) × 228.1(H)	mm
Bezel opening area	307.5(W) × 231.4(H)	mm
Weight	875 typ.	g

## ELECTRICAL ABSOLUTE MAXIMUM RATINGS

Ta=25 °C

ITEM	SYMBOL	MIN	MAX	UNIT	NOTE
Power supply voltage	V <sub>DD-VSS</sub>	-0.3	4.0	V	
Input voltage	V <sub>I</sub>	V <sub>SS</sub> -0.3	V <sub>DD</sub> +0.3	V	
CFL lamp current	I <sub>L</sub>	-	8.5	mA	

## ENVIRONMENTAL ABSOLUTE MAXIMUM RATINGS

Ta=25 °C

ITEM	SYMBOL	CONDITIONS	MIN	MAX	UNIT	NOTE
Ambient temperature	T <sub>ST</sub>	Storage	-20	60	°C	Note 1
	T <sub>OP</sub>	Operation	0	50		
Humidity	-	Ta=40 °C max.	-	85	%RH	No condensation Note 2
Vibration	-	Storage	-	1.5	G	Note 3
Shock	-	Storage	-	50	G	XYZ 11ms/direction

[ Note 1 ] Care should be taken so that the LCD module may not be subjected to the temperature beyond this specification.

[ Note 2 ] Ta>40°C: Absolute humidity shall be less than that of 85%RH/40°C.

[ Note 3 ] 10-200Hz, 30min/cycle, X/Y/Z each one cycle and except for resonant frequency.

## ELECTRICAL CHARACTERISTICS

V<sub>DD</sub>=3.3V ,fv=60Hz ,fh=48.4kHz ,f<sub>CLK</sub>=65MHz ,Ta=25°C

ITEM	SYMBOL	CONDITIONS	MIN	TYP	MAX	UNIT	NOTE
Power supply voltage	V <sub>DD-VSS</sub>		3.0	3.3	3.6	V	
LVDS input threshold voltage	V <sub>TH</sub>	High level	-	-	+100	mV	V <sub>CM</sub> =1.2V
	V <sub>TL</sub>	Low level	-100	-	-		
LVDS input common Mode voltage			1.0	1.2	1.4	V	
LVDS input termination resister	R <sub>T</sub>		-	100	-	Ω	Internal
Power Supply current	I <sub>DD</sub>	Note 1	-	(430)	800	mA	

[ Note 1 ] Under the following display image :  
Typ. value : Display pattern is 256 gray scale bar.

[ Note 2 ] V<sub>CM</sub> : Common Mode Voltage of LVDS input.

## OPTICAL CHARACTERISTICS

V<sub>DD</sub>=3.3V ,f<sub>v</sub>=60Hz ,f<sub>h</sub>=48.4kHz ,f<sub>CLK</sub>=65MHz ,T<sub>a</sub>=25°C

ITEM	SYMBOL	CONDITIONS	MIN	TYP	MAX	UNIT	NOTE	
Brightness	B	$\phi = 0^\circ$	(180)	(250)	-	cd/m <sup>2</sup>	Note 4,8	
Brightness uniformity	$\delta B$	$\phi = 0^\circ$	-	-	1.30	-	Note 5,6,8	
Contrast ratio	CR	$\phi = 0^\circ$	(300)	(500)	-	-	Note 2,4,8	
Viewing angle range	$\phi$	CR>10	$\theta = 0^\circ$	50	65	-	deg.	Note 1,2,4,8
			$\theta = 90^\circ$	60	70	-		
			$\theta = 180^\circ$	40	55	-		
			$\theta = 270^\circ$	60	70	-		
		CR>5	$\theta = 0^\circ$	70	-	-	deg.	Note 1,2,4,8
			$\theta = 90^\circ$	70	-	-		
			$\theta = 180^\circ$	50	-	-		
			$\theta = 270^\circ$	70	-	-		
Response time	Rise	tr	$\phi = 0^\circ$	-	20	-	ms.	Note 3,4,8
	Fall	tf		-	5	-		
Color of CIE Coordinate	Red	x	$\phi = 0^\circ$	(0.568)	(0.618)	(0.668)	-	Note 4,8
		y		(0.297)	(0.347)	(0.397)		
	Green	x		(0.238)	(0.288)	(0.338)		
		y		(0.545)	(0.595)	(0.645)		
	Blue	x		(0.091)	(0.141)	(0.191)		
		y		(0.025)	(0.075)	(0.125)		
	White	x		(0.253)	(0.303)	(0.353)		
		y		(0.280)	(0.330)	(0.380)		

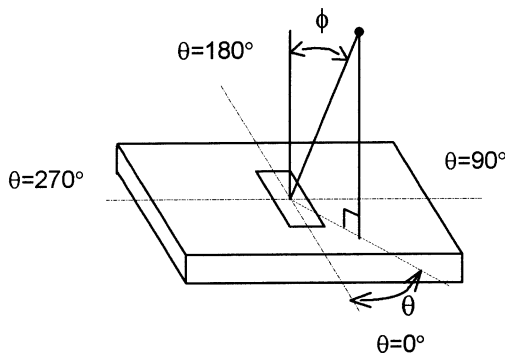

[ Note 1 ]  $\phi$  and  $\theta$

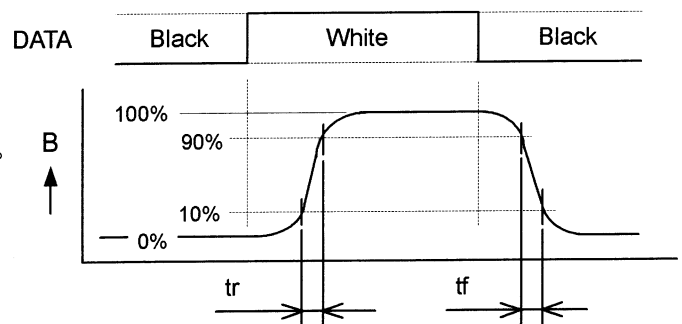

[ Note 3 ] Response time

[ Note 2 ] Contrast ratio "CR"

$$CR = \frac{\text{Brightness at White}}{\text{Brightness at Black}}$$

[ Note 4 ] This shall be measured at center point No.3 of Note 7.

[ Note 5 ] The brightness shall be the average of the following 5 points of Note 7.

[ Note 6 ] The brightness uniformity shall be calculated by using following formula.

$$\delta B = \frac{\text{Maximum brightness of 5 points}}{\text{Minimum brightness of 5 points}}$$

[ Note 7 ] Measurement points

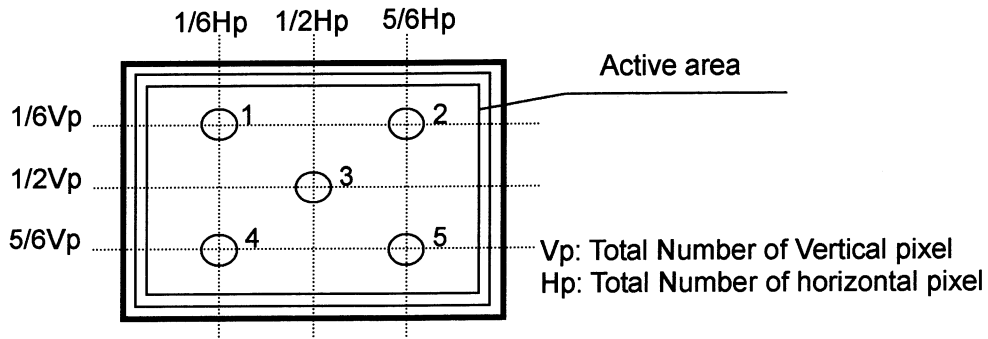

[ Note 8 ] Measurement condition

- (1) Measurement equipment: BM-5A (TOPCON Corp.), Field=2°
- (2) Ambient temperature Ta: 25 ± 2°C
- (3) LCD: All pixels are WHITE, VDD=3.3V, fV=60Hz, fh=48.4kHz
- (4) Measure after 30 minutes of CFL warm up.
- (5) IL=8.0 mArms

**BACKLIGHT CHARACTERISTICS**

This module is used the backlight with 2 CFL.

The characteristics of a single lamp are shown in the following table.

Ta=25°C

ITEM	SYM.	CONDITIONS	MIN	TYP	MAX	UNIT	NOTE
Lamp voltage	V <sub>L</sub>		-	(610)	-	V <sub>rms</sub>	at IL=8.0mArms
Lamp current	I <sub>L</sub>		3	-	8	mArms	(Recommended value)
Operating frequency	f <sub>L</sub>		40	-	65	kHz	(Recommended value)
Start up voltage	V <sub>s</sub>		-	-	(1500)	V <sub>rms</sub>	at Ta=0°C
Operating life	t <sub>OL</sub>		40000	-	-	Hours	at IL=8.0 mArms

[ Note 1 ] Backlight driving conditions (operating frequency f<sub>L</sub> especially) may interfere with horizontal frequency f<sub>H</sub>, causing the beat or flicker on the display. Therefore the operating frequency f<sub>L</sub> shall be adjusted in relation to horizontal frequency f<sub>H</sub> to avoid interference. And please make sure that frequency, phase of Drive voltage and current of four lamps, match each other.

[ Note 2 ] The inverter open voltage should be larger than start up voltage, otherwise backlight may blinking for a moment after turns on or not be turned on. And this voltage should be applied to lamp for more than 1 second to start up, otherwise backlight may not be turned on.

[ Note 3 ] If driving current waveform is asymmetrical, mercury deviation inside of CFL will incline to one side and consequently abnormal lighting may occur. To prevent such unfavorable lighting, driving current waveform is asked to have unbalance rate of less than 10% and wave-height rate of less than  $\sqrt{2} \pm 10\%$ . And this driving waveform shall be confirmed in your system.

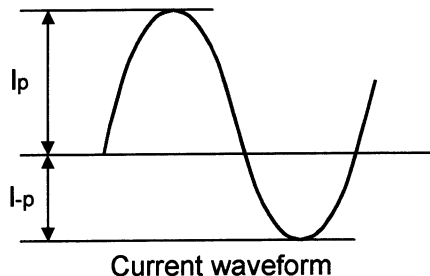

$$\text{Unbalance rate} = |I_p - I-p| / I_L \times 100 (\%)$$

$$\text{Wave-height rate} = I_p \text{ (or } I-p) / I_L$$

I<sub>p</sub> : High peak value

I-p : Low peak value

I<sub>L</sub> : Effective value

[ Note 4 ] The inverter of ground reference type should be used. The inverter of ground floating type should not be used.

**BLOCK DIAGRAM**

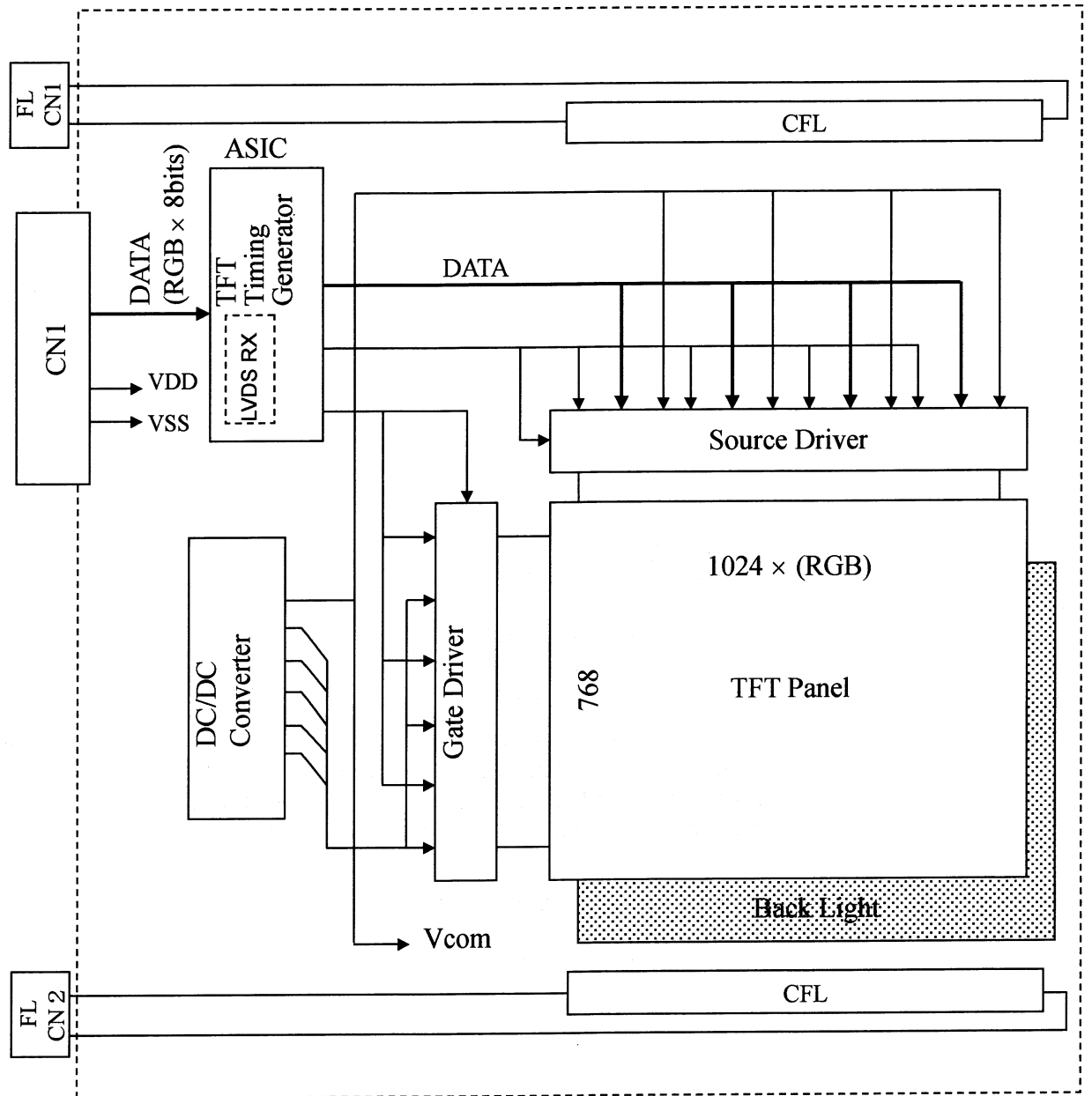

[ Note 1 ] ASIC converts incoming RGB × 8 bits data into outgoing RGB × 6 bits data with frame rate modulation and dithering, which enables LCD to perform 'pseudo-8 bits color'.

## INTERFACE PIN CONNECTIONS

### LCM : CN1

PIN NO.	SYMBOL	FUNCTION
1	VDD	Power Supply (3.3V normal)
2	VDD	Power Supply (3.3V normal)
3	VSS	Ground
4	VSS	Ground
5	Rin0-	Receiver Signal (-)
6	Rin0+	Receiver Signal (+)
7	VSS	Ground
8	Rin1-	Receiver Signal (-)
9	Rin1+	Receiver Signal (+)
10	VSS	Ground
11	Rin2-	Receiver Signal (-)
12	Rin2+	Receiver Signal (+)
13	VSS	Ground
14	RCLK-	Clock Signal (-)
15	RCLK+	Clock Signal (+)
16	VSS	Ground
17	Rin3-	Receiver Signal (-)
18	Rin3+	Receiver Signal (+)
19	VSS	Ground
20	NC	Reserved

CN1 : DF14H-20P-1.25H (HIROSE)

Suitable mating connector: DF14-20S-1.25 (HIROSE)

[ Note 1 ] Internal termination resistors of LVDS input lines are 100 ohms.

### Back Light : FLCN1,2

PIN NO.	SYMBOL	FUNCTION
1	H.V	High voltage for CFL
2	NC	-
3	LGND	Low voltage for CFL

FLCN1,2: BHR-03VS-1 (JST) or equivalent

Suitable mating connector: SM02(8.0)B-BHS-1-TB (JST)

## INTERFACE (LVDS) DATA ASSIGNMENT

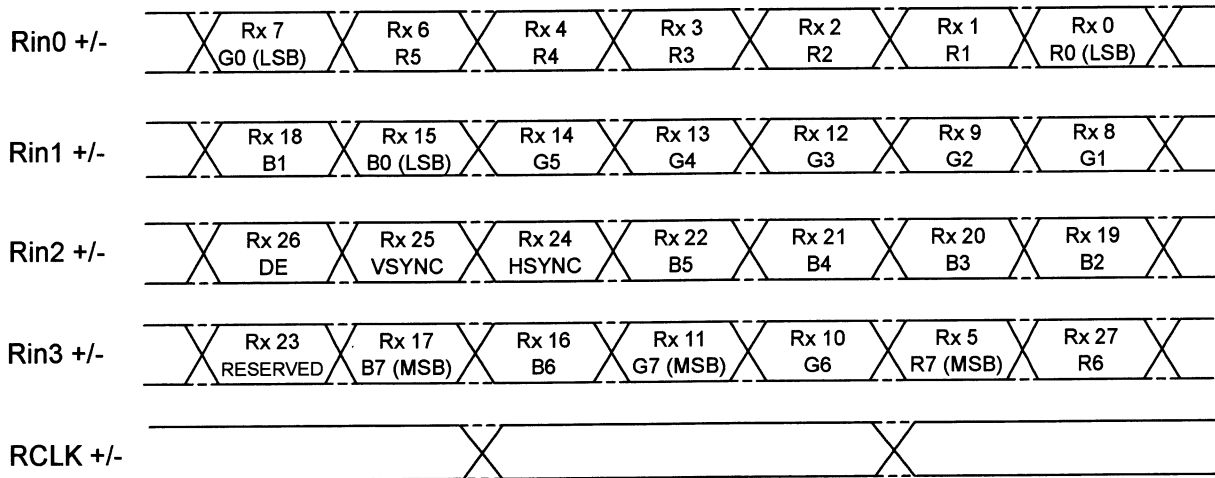

## INTERFACE SIGNALS

SYMBOL	FUNCTION
DCLK	Data Clock
HSYNC	Horizontal Sync - This signal initiates a new line(negative).
VSYNC	Vertical Sync - This signal initiates a new frame(negative).
DE	Data Enable (positive)
R0	Red Data (LSB)
R1	Red Data
R2	Red Data
R3	Red Data
R4	Red Data
R5	Red Data
R6	Red Data
R7	Red Data (MSB)
G0	Green Data (LSB)
G1	Green Data
G2	Green Data
G3	Green Data
G4	Green Data
G5	Green Data
G6	Green Data
G7	Green Data (MSB)
B0	Blue Data (LSB)
B1	Blue Data
B2	Blue Data
B3	Blue Data
B4	Blue Data
B5	Blue Data
B6	Blue Data
B7	Blue Data (MSB)

[ Note 1 ] The valid synchronous signals are DCLK and DE, HSYNC and VSYNC are invalid.

[ Note 2 ] INTERFACE SIGNALS are loaded from LVDS-transmitter to TFT Timing generator with LVDS sequence. (See BLOCK DIAGRAM.)



## INTERNAL SIGNAL TIMING PARAMETERS ( DE\_MODE )

PARAMETER		SYMBOL	MIN	TYP	MAX	UNIT	NOTE
DCLK	Frequency	fCLK	60.0	65.0	(79.0)	MHz	tCLK=1/fCLK
	Duty	D	(0.40)	0.50	(0.60)	-	D=tCLKL/tCLK
DE	Setup Time	tSI	(3.0)	-	-	ns	for DCLK
	Hold Time	tHI	(3.0)	-	-	ns	
	Horiz. Period	tHP	(1050)	1344	(1800)	tCLK	
	Horiz. DE	tHDE	1024	1024	1024	tCLK	
	Horiz. Frequency	fH	-	48.4	(60)	kHz	(fH=1/tHP)
	Vert. Period	tVP	(773)	806	(1200)	tHP	fV=60Hz Typ.
	Vert. DE	nVDE	768	768	768	n	
DATA	Vert. Frequency	fV	(45)	60	(75)	Hz	(fV=1/tVP)
	Setup Time	tSD	(3.0)	-	-	ns	for DCLK
	Hold Time	tHD	(3.0)	-	-	ns	

[ Note 1 ] These signal timing parameters are specified at the digital input of LVDS transmitter. With respect to setup time and hold time for DE and DATA signals, please refer to input signal specification of LVDS transmitter.

Recommended LVDS transmitter : DS90C385(NS)

[ Note 2 ] The values in this table only show the normal operating conditions of internal logic circuit, and it does not assure the conditions for appearance and display quality. The conditions for appearance and display quality are shown in the inspection standard separately.

**INTERNAL SIGNAL TIMING DIAGRAM ( DE\_MODE )**

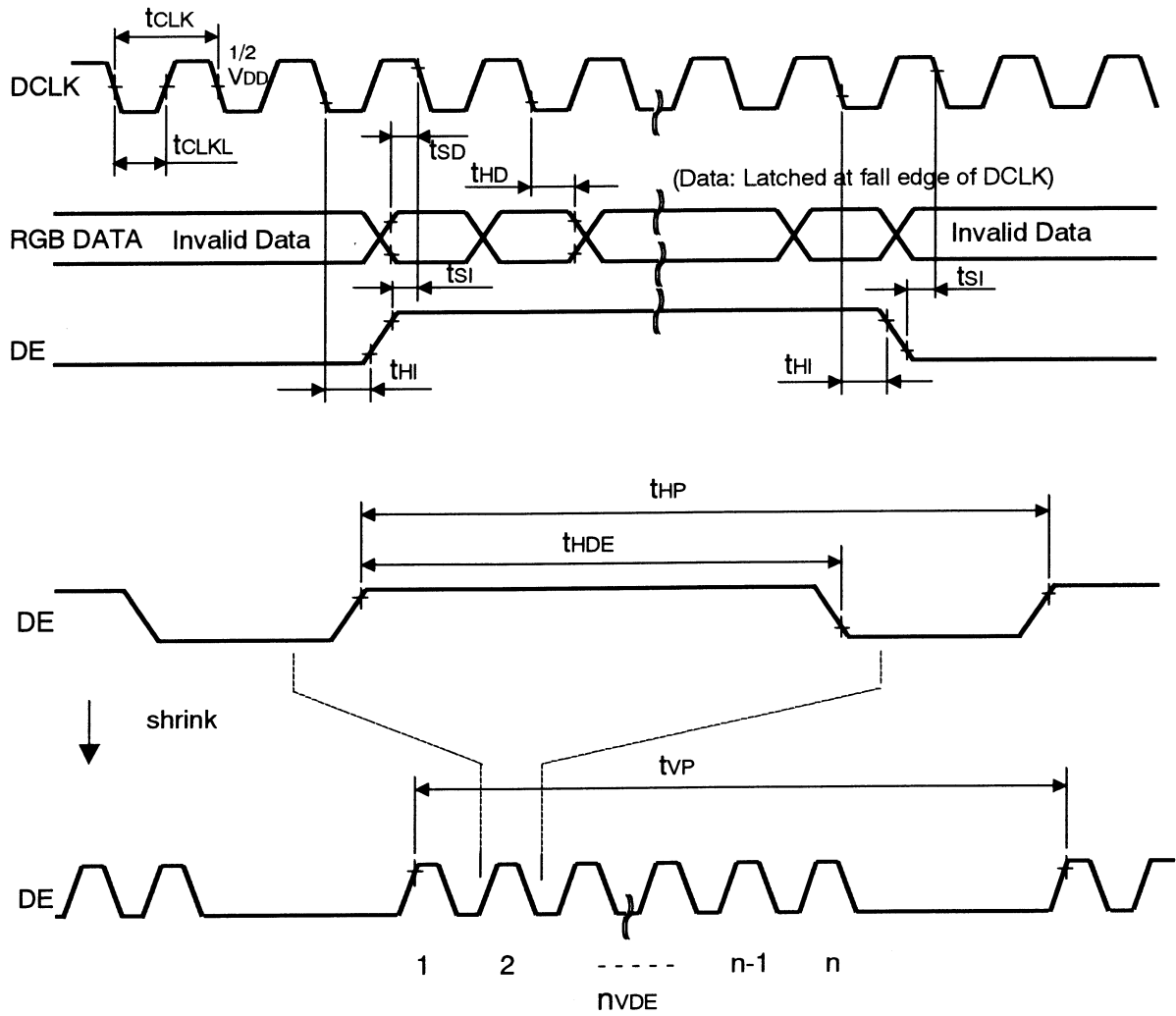

**RELATIONSHIP BETWEEN INPUT DATA AND DISPLAY POSITION**

1·1	1·2	1·3	.....	1·1023	1·1024
2·1	2·2				2·1024
3·1					
·					·
·					·
·					·
·					·
767·1					767·1024
768·1	768·2	.....		768·1023	768·1024

Vp·Hp    R G B

## RELATIONSHIP BETWEEN INPUT DATA AND DISPLAY COLOR

INPUT DATA DISPLAY COLOR		R DATA								G DATA								B DATA							
		MSB				LSB				MSB				LSB				MSB				LSB			
		R7	R6	R5	R4	R3	R2	R1	R0	G7	G6	G5	G4	G3	G2	G1	G0	B7	B6	B5	B4	B3	B2	B1	B0
BASIC COLOR	BLACK	L	L	L	L	L	L	L	L	L	L	L	L	L	L	L	L	L	L	L	L	L	L	L	
	RED	H	H	H	H	H	H	H	H	L	L	L	L	L	L	L	L	L	L	L	L	L	L	L	
	GREEN	L	L	L	L	L	L	L	L	H	H	H	H	H	H	H	H	L	L	L	L	L	L	L	
	BLUE	L	L	L	L	L	L	L	L	L	L	L	L	L	L	L	L	H	H	H	H	H	H	H	
	CYAN	L	L	L	L	L	L	L	L	H	H	H	H	H	H	H	H	H	H	H	H	H	H	H	
	MAGENTA	H	H	H	H	H	H	H	H	L	L	L	L	L	L	L	L	L	L	L	L	L	L	L	
	YELLOW	H	H	H	H	H	H	H	H	H	H	H	H	H	H	H	H	L	L	L	L	L	L	L	
	WHITE	H	H	H	H	H	H	H	H	H	H	H	H	H	H	H	H	H	H	H	H	H	H	H	
RED	BLACK	L	L	L	L	L	L	L	L	L	L	L	L	L	L	L	L	L	L	L	L	L	L		
	RED(1) *	L	L	L	L	L	L	L	H	L	L	L	L	L	L	L	L	L	L	L	L	L	L		
	RED(2) *	L	L	L	L	L	L	H	L	L	L	L	L	L	L	L	L	L	L	L	L	L	L		
	RED(3) *	L	L	L	L	L	L	H	H	L	L	L	L	L	L	L	L	L	L	L	L	L	L		
	RED(4)	L	L	L	L	L	H	L	L	L	L	L	L	L	L	L	L	L	L	L	L	L	L		
	:																								
	RED(251) *	H	H	H	H	H	L	H	H	L	L	L	L	L	L	L	L	L	L	L	L	L	L		
	RED(252)	H	H	H	H	H	H	L	L	L	L	L	L	L	L	L	L	L	L	L	L	L	L	L	
		H	H	H	H	H	H	L	H	L	L	L	L	L	L	L	L	L	L	L	L	L	L	L	
		H	H	H	H	H	H	H	L	L	L	L	L	L	L	L	L	L	L	L	L	L	L	L	
H		H	H	H	H	H	H	H	L	L	L	L	L	L	L	L	L	L	L	L	L	L	L		
GREEN	BLACK	L	L	L	L	L	L	L	L	L	L	L	L	L	L	L	L	L	L	L	L	L	L		
	GREEN(1) *	L	L	L	L	L	L	L	L	L	L	L	L	L	L	L	H	L	L	L	L	L	L		
	GREEN(2) *	L	L	L	L	L	L	L	L	L	L	L	L	L	L	H	L	L	L	L	L	L	L		
	GREEN(3) *	L	L	L	L	L	L	L	L	L	L	L	L	L	L	H	H	L	L	L	L	L	L		
	GREEN(4)	L	L	L	L	L	L	L	L	L	L	L	L	L	H	L	L	L	L	L	L	L	L		
	:																								
	GREEN(251) *	L	L	L	L	L	L	L	L	H	H	H	H	H	L	H	H	L	L	L	L	L	L		
	GREEN(252)	L	L	L	L	L	L	L	L	H	H	H	H	H	H	L	L	L	L	L	L	L	L	L	
		L	L	L	L	L	L	L	L	H	H	H	H	H	H	L	H	L	L	L	L	L	L	L	
		L	L	L	L	L	L	L	L	H	H	H	H	H	H	H	L	L	L	L	L	L	L	L	
L		L	L	L	L	L	L	L	H	H	H	H	H	H	H	H	L	L	L	L	L	L	L		
BLUE	BLACK	L	L	L	L	L	L	L	L	L	L	L	L	L	L	L	L	L	L	L	L	L	L		
	BLUE(1) *	L	L	L	L	L	L	L	L	L	L	L	L	L	L	L	L	L	L	L	L	L	H		
	BLUE(2) *	L	L	L	L	L	L	L	L	L	L	L	L	L	L	L	L	L	L	L	L	L	H		
	BLUE(3) *	L	L	L	L	L	L	L	L	L	L	L	L	L	L	L	L	L	L	L	L	L	H		
	BLUE(4)	L	L	L	L	L	L	L	L	L	L	L	L	L	L	L	L	L	L	L	L	H	L		
	:																								
	BLUE(251) *	L	L	L	L	L	L	L	L	L	L	L	L	L	L	L	H	H	H	H	H	L	H		
	BLUE(252)	L	L	L	L	L	L	L	L	L	L	L	L	L	L	L	H	H	H	H	H	H	L	L	
		L	L	L	L	L	L	L	L	L	L	L	L	L	L	L	H	H	H	H	H	H	L	L	
		L	L	L	L	L	L	L	L	L	L	L	L	L	L	L	H	H	H	H	H	H	L	L	
L		L	L	L	L	L	L	L	L	L	L	L	L	L	L	H	H	H	H	H	H	L	L		

[ Note 1 ] Color(n) --- 'n' indicates gray scale step.

[ Note 2 ] '\*' Mark shows using the frame rate modulation and dithering.

## POWER ON/OFF SEQUENCE REQUIREMENT

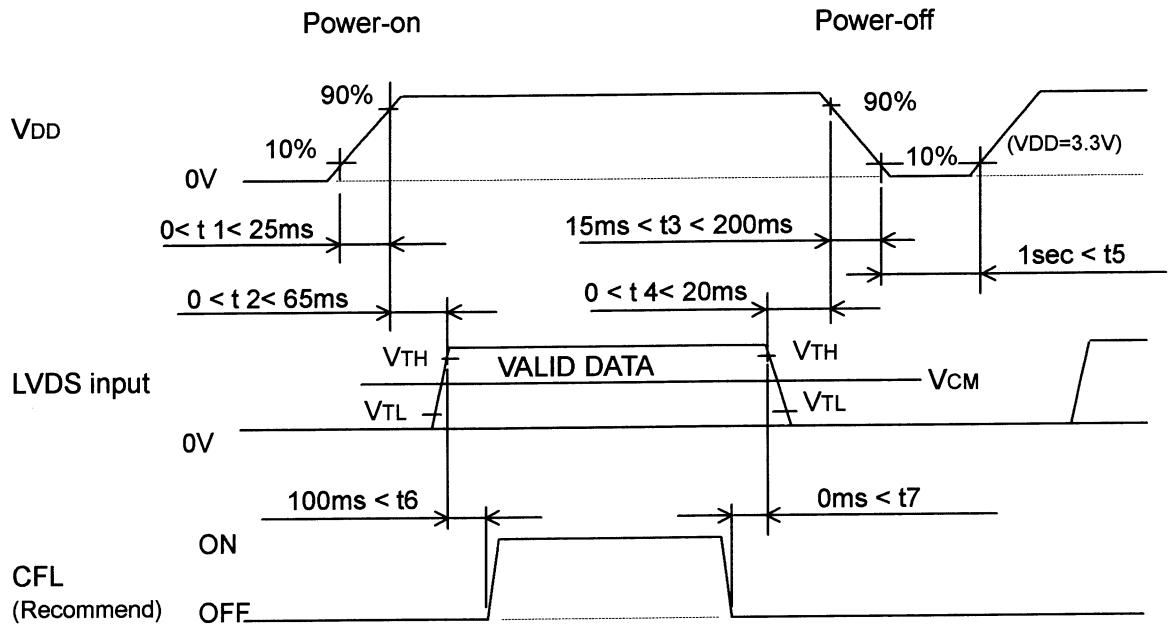

[Note1] When the power is off, LVDS input must be kept at either low level or high impedance.

[Note2] When VDD is on, please avoid floating state of LVDS input at invalid period.

[Note3] Power sequence for CFL (backlight) is not specified especially, however it is recommended to consider some timing difference between LVDS input as shown above.

If backlight lights on before LCD starts function, or if backlight is kept on after LCD stopped function, screen may look white for a moment or abnormal image may be displayed.

This is caused by variation in output signal from timing generator at LVDS input on or off. It does not cause damage to liquid crystal molecule and driving circuit.

## ***PRECAUTIONS (INSTRUCTIONS FOR SAFE AND PROPER USE)***

### **1. Instructions for safety**

- (1) Please do not disassemble or modify LCD module to avoid the possibility of electric shock, damage of electronic components, scratch at display surface and invasion of foreign particles. In addition, such activity may result in fire accident due to burning of electronic component.  
LCD module disassembled or modified by customer is out of warranty.
- (2) Please be careful in handling of LCD module with broken glass.  
When the display glass breaks, please pay attention not to injure your fingers. The display surface has the plastic film attached, which prevents dispersion of glass pieces, however touching broken edge will injure your fingers. Also CFL (Cold Cathode Fluorescent Lamp) is made of glass, therefore please pay attention in the same way.
- (3) Please do not touch the fluid flown out of broken display glass.  
If the fluid should stick to hand or clothes, wipe off with soap or alcohol immediately and then wash it with water. If the fluid should get in eyes, wash eyes immediately with washing lotion for more than 15 minutes and then consult the doctor.
- (4) Please make secure connection of CFL connector.  
Please make sure that CFL connector from LCD module is connected with output connector on inverter circuit securely. Poor connection may cause smoke or fire accident due to high voltage in circuit. If connection may not be secure, please switch off the power supply for LCD module and CFL and then make secure connection.  
Please do not make connection with another connector than recommended mating connector.
- (5) CFL contains mercury inside. Please follow regulations or rules established by local autonomy at its disposal.
- (6) Please be careful to electric shock.  
Before handling LCD module, please switch off the power supply.  
Since high voltage is applied to CFL terminal, cable, connector and inverter circuit in operation mode, touching them will cause electric shock.

### **2. Instructions for designing**

- (1) **Mounting of LCD**  
Please fix LCD module at all mounting flanges shown in this specification for installation onto system. The used screws should have proper dimensions.  
Furthermore, designing of mounting parts should be adequate so that LCD module is not warped or twisted, to achieve good display quality.
- (2) **Polarity of power supply for CFL**  
Please give careful consideration in designing so that each polar of cable should be connected correctly at assembling (i.e. high voltage side is connected to high voltage side and low voltage side is connected to low voltage side). Since longer CFL cable may cause insatiable start-up of CFL and reduction of brightness, please make cable short as much as possible.

- (3) **Power supply for CFL**  
 Please design the circuit so that high voltage output can be kept for more than 1 second. The shorter time may not start up CFL. The driving inverter circuit is recommended to be the type which CFL current can be controlled.  
 The type which voltage is controlled is not recommended, because it may cause big current under high temperature and insatiable start-up of CFL under low temperature.  
 If LCD display turned into reddish screen or remarkable brightness decreases by the end of CFL life, please make a consideration of design that the backlight is turned off immediately.
- (4) **Heat radiation**  
 CFL generates heat at lighting and causes temperature rise inside system. Therefore, designing to radiate heat like radiation slits at cabinet is recommended to meet the specified operating temperature range for LCD module.
- (5) **Noise on power line**  
 Spike noise contained in power line causes abnormal operation of driving circuit and abnormal display. To avoid it, spike noise should be suppressed below VDD +/- 200mVp-p. (In any case, absolute maximum rating should be kept.)
- (6) **Power sequence**  
 Before LCD module is switched on, please make sure that power supply and input signals of system, testing equipment, etc. meet the recommended power sequence.
- (7) **Absolute maximum rating**  
 Absolute maximum rating specified in this specification has to be kept in any case. It shows the maximum that cannot be exceeded.  
 Exceeding it may cause burning or non-recoverable break of electronic components in circuit. Please make system design so that absolute maximum rating is not exceeded even if ambient temperature, input signal and components are varied.
- (8) **Protection for power supply**  
 Please study to adapt protection for power supply against trouble of LCD module, depending on usage condition of system. Fuse installed on LCD module should be never modified. Any modification to make the function of fuse ineffective may cause burning or break of printed wiring board or other components at circuit trouble.
- (9) **Protection against electric shock**  
 High voltage is applied to CFL connector, inverter circuit and CFL at lighting. Please make design not to expose or be accessible to such high voltage parts to avoid electric shock.
- (10) **Protection cover and cut-off filter for ultraviolet rays**  
 When LCD module is used under severe condition like outdoor, it is recommended to use transparent protection cover over display surface to avoid scratches and invasion of dust and water. In addition, when LCD module is exposed to direct sun light for long time, use of cut-off filter for ultraviolet rays is also recommended. Please be careful not to get condensation.

### 3. Instructions for use and handling

- (1) **Protection against Static electricity**  
 C-MOS LSI and semiconductors are easily damaged by static discharge. LCD module should be handled on conductive mat by person grounded with wrist strap etc. to avoid getting static electricity. Please be careful not to generate static electricity during operation.

- (2) **Protection against dust and stain**  
LCD module should be handled in circumstance as clean as possible.  
It is recommended to wear fingerstalls or ductless and soft gloves before handling to avoid getting dust or stain on display surface.
- (3) **Protection film for display surface**  
It is recommended to remove protection film at nearly final process of assembling to avoid getting scratch or dust. To remove film, please pick up its edge with dull-head tweezers or cellophane tape at first and then remove film gradually taking more than 3 seconds. If film is removed quickly, static electricity may be generated and may damage semiconductors or electronic components.
- (4) **Contamination of display surface**  
When display surface of LCD module is contaminated, please wipe the surface softly with cotton swab or clean cloth. If it is not enough, please take it away with cellophane tape or wipe the surface with cotton swab or clean cloth containing benzine. In this case, please be careful so that benzine does not get in inside of LCD module, because it may be damaged.
- (5) **Water drop on LCD surface**  
Please do not leave LCD module with water drop. When the display surface gets water drop, please wipe it off with cotton swab or soft cloth immediately, otherwise display surface will be deteriorated.  
If water gets in inside of LCD module, circuit may be damaged.
- (6) **Please make sure that LCD module is not warped or twisted at installation into system. Even temporary warp or twist may be the cause for failure.**
- (7) **Mechanical stress**  
Please be careful not to apply strong mechanical stress like drop or shock to LCD module. Such stress may cause break of display glass and Lamp or may be the cause for failure.
- (8) **Pressure to display surface**  
Please be careful not to apply strong pressure to display surface. Such pressure may cause scratches at surface or may be the cause of failure.
- (9) **Protection against scratch**  
Please be careful not to hit, press or rub the display surface with hard material like tools. In addition, please do not put heavy or hard material on display surface, and do not stack LCD modules. Polarizer at front surface can be easily scratched.
- (10) **Plugging in of connector**  
Please be careful not to apply strong stress to connector part of LCD module at plugging in or out, because strong stress may damage the inside connection. At plugging in connector, place LCD module on the flat surface and hold the backside of connector on LCD module. Please make sure that connector is plugged in correctly. Insecure connection may be the cause for failure during operation.  
In addition, please be careful not to put the connecting cable between cabinet of system and LCD module at installing LCD module into system.
- (11) **Handling of CFL cable and FPC (Flexible Printed Circuit)**  
Please be careful not to pull or scratch CFL cable, because CFL or soldered part of cable may be damaged consequently.  
Also FPC should not be pulled or scratched.
- (12) **Switching off before plugging in connector**  
Please make sure that power is switched off before plugging in connector.  
If power is on at plugging in or out, circuit of LCD module may be damaged.  
When LCD is switched on for test or inspection, please make sure that power supply and input signals of driving system meet the specified power sequence.

- (13) Temperature dependence of LCD display  
Response speed (optical response) of LCD display is dependent on temperature.  
Under low temperature, response speed is slower.  
Also brightness and chromaticity change slightly depending on temperature.
- (14) Slow light-up of CFL under low temperature  
Under low temperature, start-up of CFL gets difficult. (The time from switch-on to stable lighting becomes longer.)  
As characteristic of CFL, operation under low temperature makes the life time shorter. To avoid this, it is recommended to operate under normal temperature.
- (15) Condensation  
LCD module may get condensation on its display surface and inside in the circumstance where temperature changes much in short time.  
Condensation can cause deterioration or failure. Therefore, please be careful not to get condensation.
- (16) Remaining of image  
Displaying the same pattern for long time may cause remaining of image even after changing the pattern. This is not failure but will disappear with time.

#### **4. Instructions for storage and transportation**

- (1) Storage  
Please store LCD module in the dark place of room temperature and low humidity in original packing condition, to avoid condensation that may cause failure.  
Since sudden temperature change may cause condensation, please store in circumstance of stable temperature.
- (2) Stacking number  
Since excessive weight causes deformation and damage of carton box, please stack only up to the number stated on carton box for storage and transportation.
- (3) Handling  
Since LCD module consists of glass and precise electronic components, it will be damaged by excessive shock and drop. Therefore, please handle the carton box carefully to minimize shock at loading, reloading and transportation.



# Outer Dimensions (FRONT SIDE)

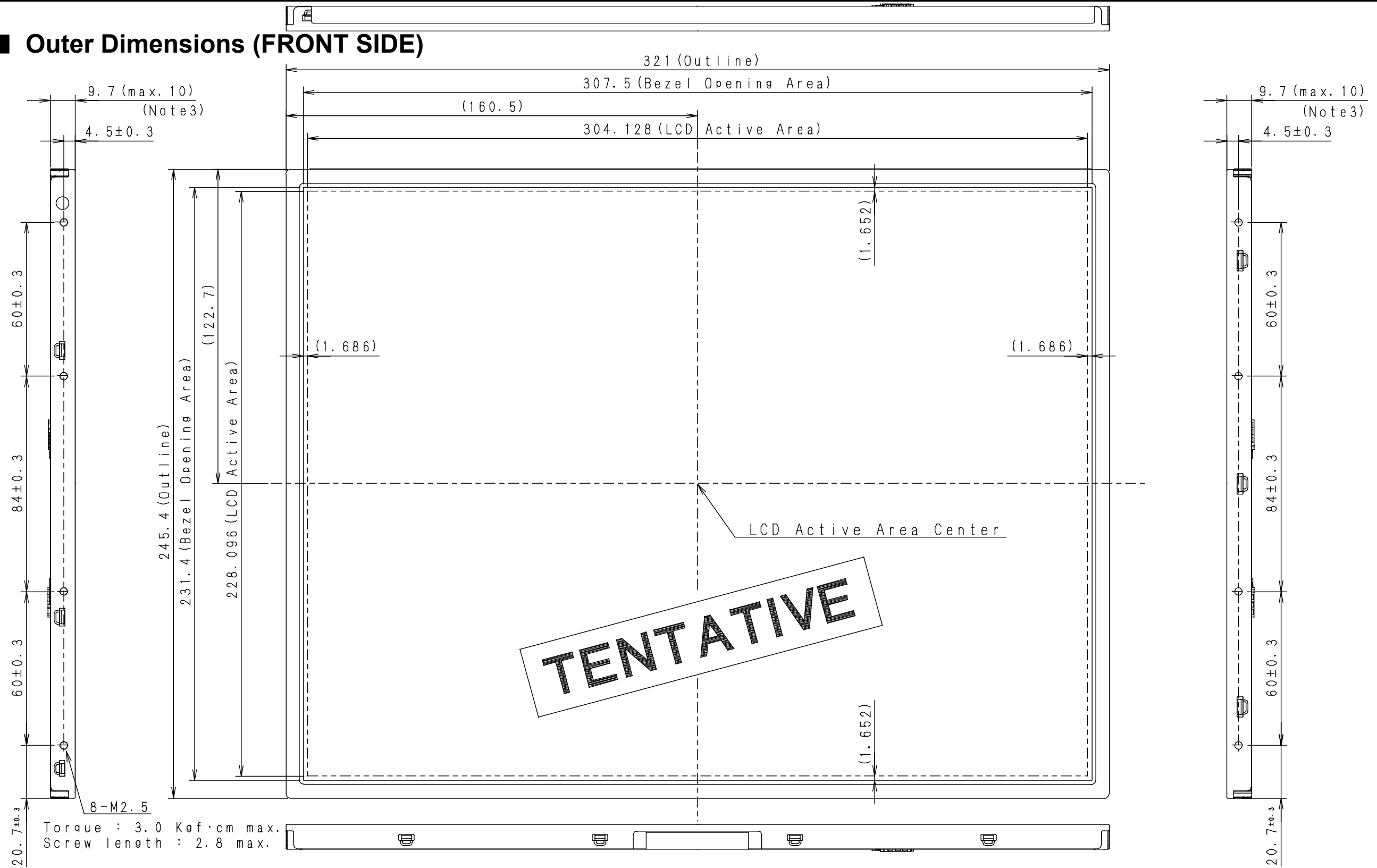

Note1: Unspecified dimension tolerances are ±0.5mm.  
 Note2: This drawing is only preliminary data and can be changed without previous notices.  
 Note3: This dimension is without connector.  
 Note4: Measuring force : 750 ± 250 (gf·cm)

■ Outer Dimensions (BACK SIDE)

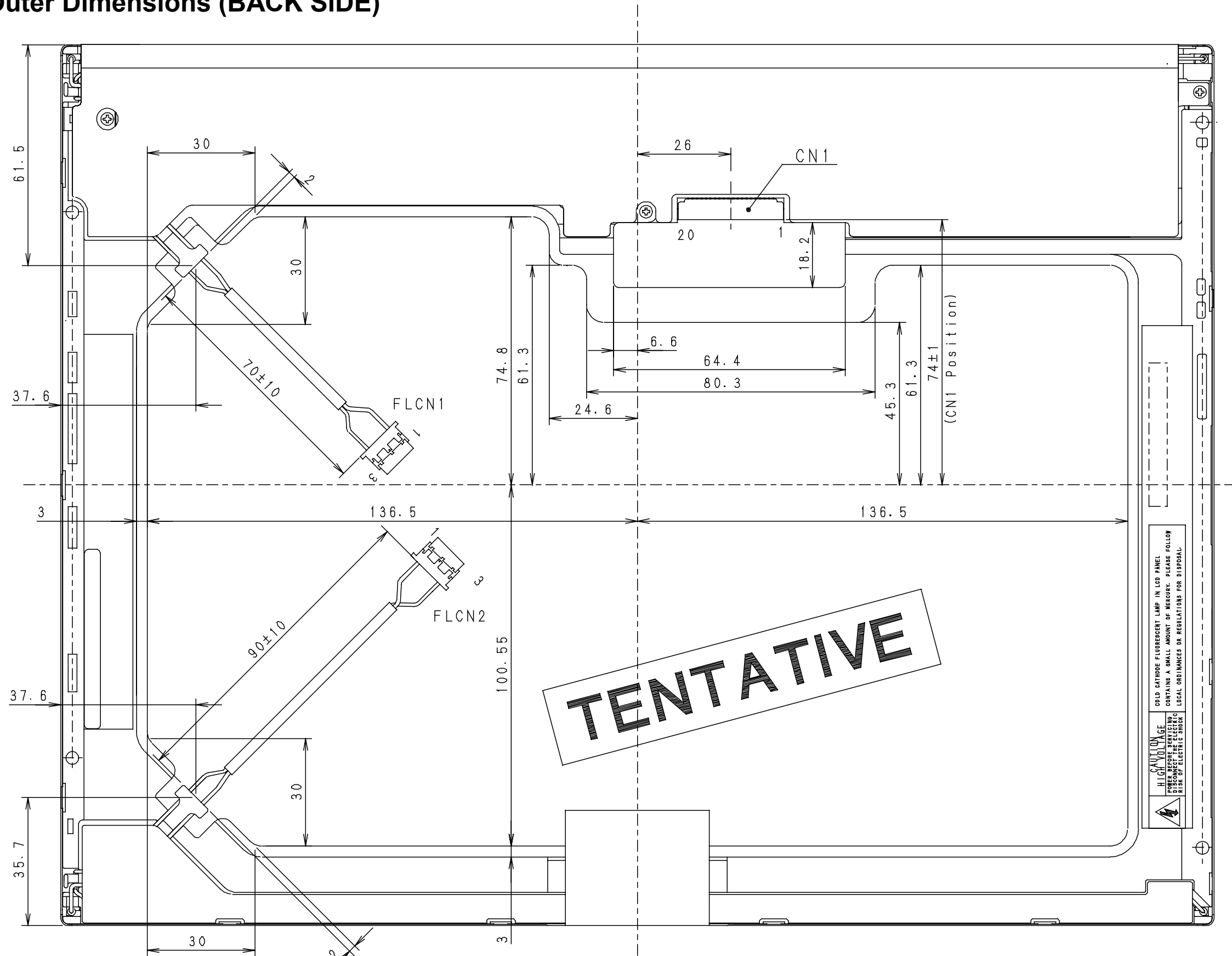

CN1 : DF14H-20P-1.25H (HIROSE)  
 FLCN1, 2 : BHR-03VS-1 (JST)  
 PIN 1 : HOT  
 PIN 3 : GND